

Demeyere

GROUP

SAV
SPAREPARTS
KUNDERDIENST
POST VENTAS
SERVICE NA VERKOOP
SERVIZIO POST-VENDITA
SERVICO DEPOS DE VENDA
SERWIS POGWARANCYJNY

109432

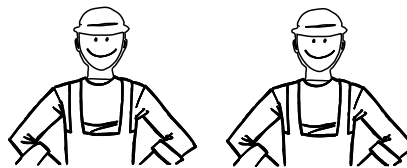
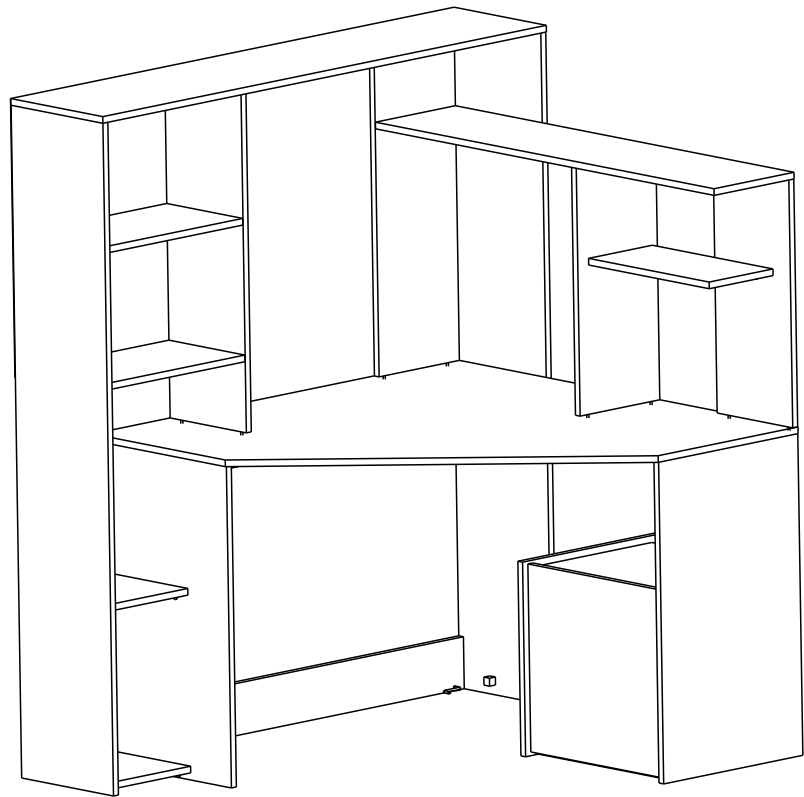
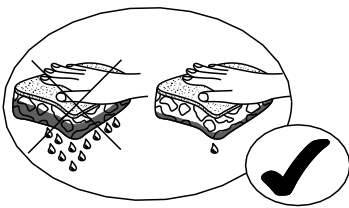
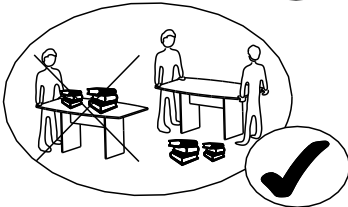
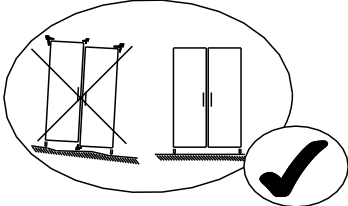
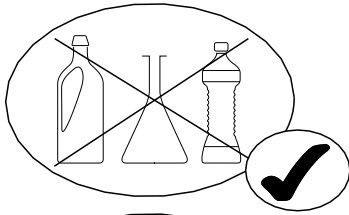

2H 30MN

FR SECURITE

RESPECTER LES INSTRUCTIONS DE MONTAGE DECRITES DANS LA NOTICE.

EN CAUTION

FOLLOW CAREFULLY THE ASSEMBLING INSTRUCTIONS DESCRIBED IN THE DIRECTIONS.

DE SICHERHEITSVORSCHRIFTEN

BEACHTEN SIE BITTE UNBEDINGT DIE ANGEGBENEN AUFBAUVORSCHRIFTEN.

ES SEGURIDAD

RESPECTAR LAS INSTRUCCIONES DE MONTAJE DESCRIBIDAS EN EL FOLLETO.

NL VEILIGHEID

DE IN DE GEBRUIKSAANWIJZING BESCHREVEN INSTRUCTIES RESPECTEREN.

IT SICUREZZA

RISPETTARE LE ISTRUZIONI DI MONTAGGIO DESCRITTE NEEL'AVVERTENZA.

PT SEGURANCA

RESPEITAR AS INSTURACOS DE MONTAGEM DESCREVEDAS NA INSTRUCOES DE USO.

PL UWAGA

PROSZE PRZESTRZEGAC INSTRUKCJI MONTAZU.

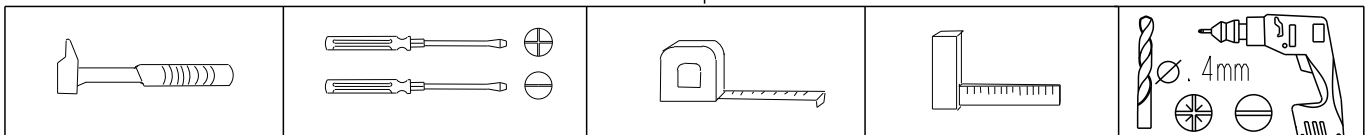

Fabrication FRANCAISE

1 / 16

REP	DIM	QTE
1	1514 x 294	1
2	724 x 423	1
3	1100 x 1100	1
4	1080 x 117	2
5	1514 x 294	1
6	1348 x 295	1
7	775 x 244	2
8	452 x 243	2
9	221 x 293	2
10	1084 x 243	1
11	558 x 242	2
12	386 x 194	1
13	438 x 423	1
14	724 x 423	1
15	427 x 361	2
16	423 x 423	1
17	426 x 420	1
18	628 x 480	1

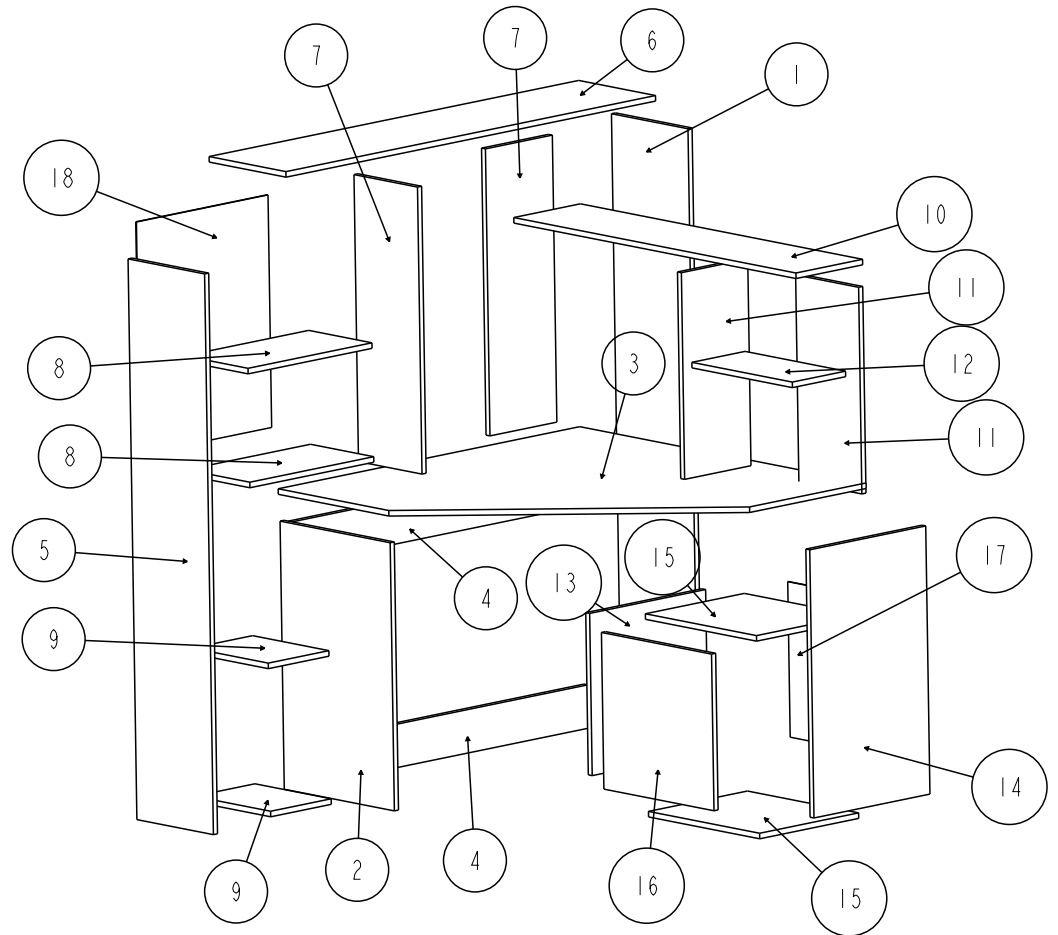

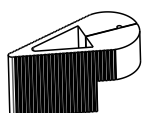
913	X 1	331144	X 1
			
VBA TR 4x30			

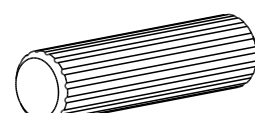
729	X 16
	
8x30	

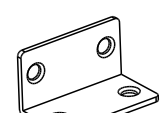
340057	X 1
	

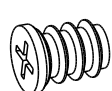
928	X 4
	
EURO TF 6,3x9	

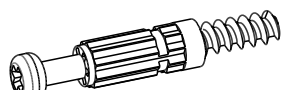
70	X 34
	
ø5 x 39	

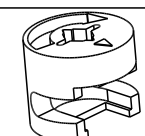
71	X 34
	
Ht : 11,9mm	

720	X 9
	

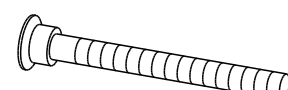
340750	X 10
	
6 PANS 7x50	

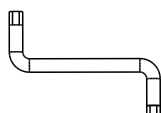
434	X 1
	

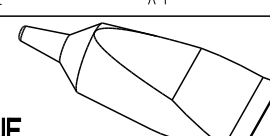
732	X 1
	
GLUE	

949	X 4
	
VBA TF 3.5x15	

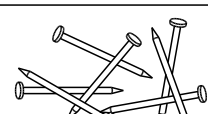
604757	X 1
	
x30	

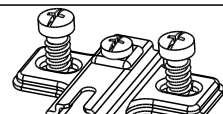
333009	X 2
	

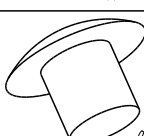
340077	X 3
	
ø5mm Ht : 6mm	

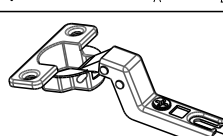
333010	X 2
	

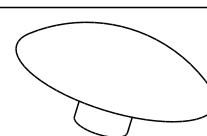
340042	X 18
	

1

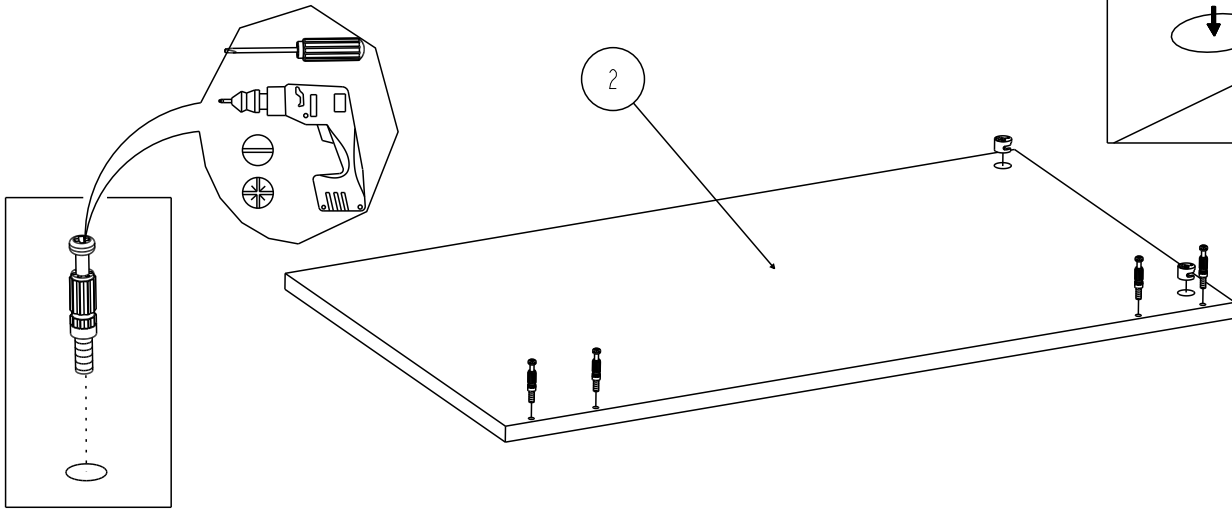
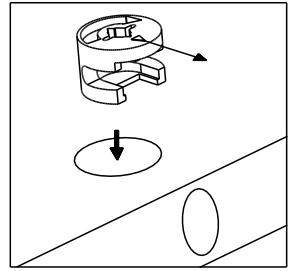
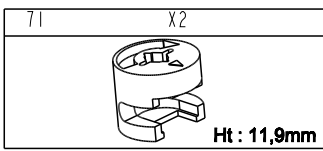
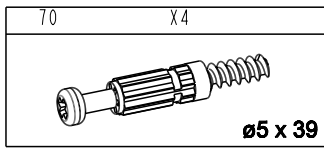

2

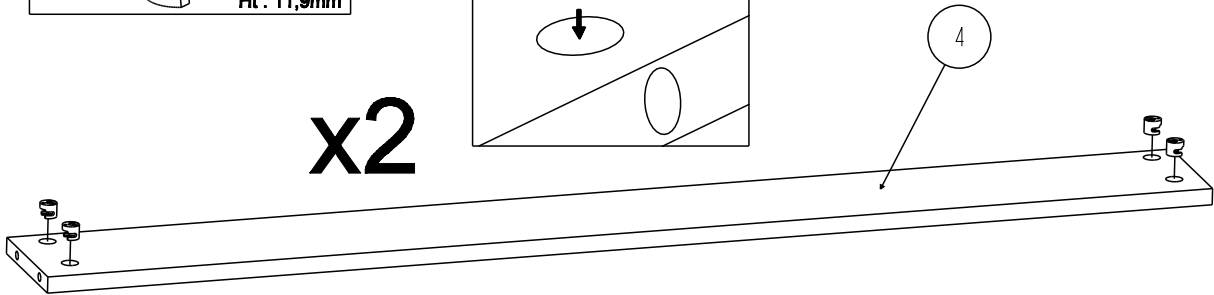
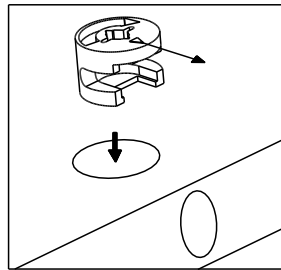
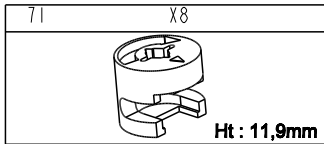

3

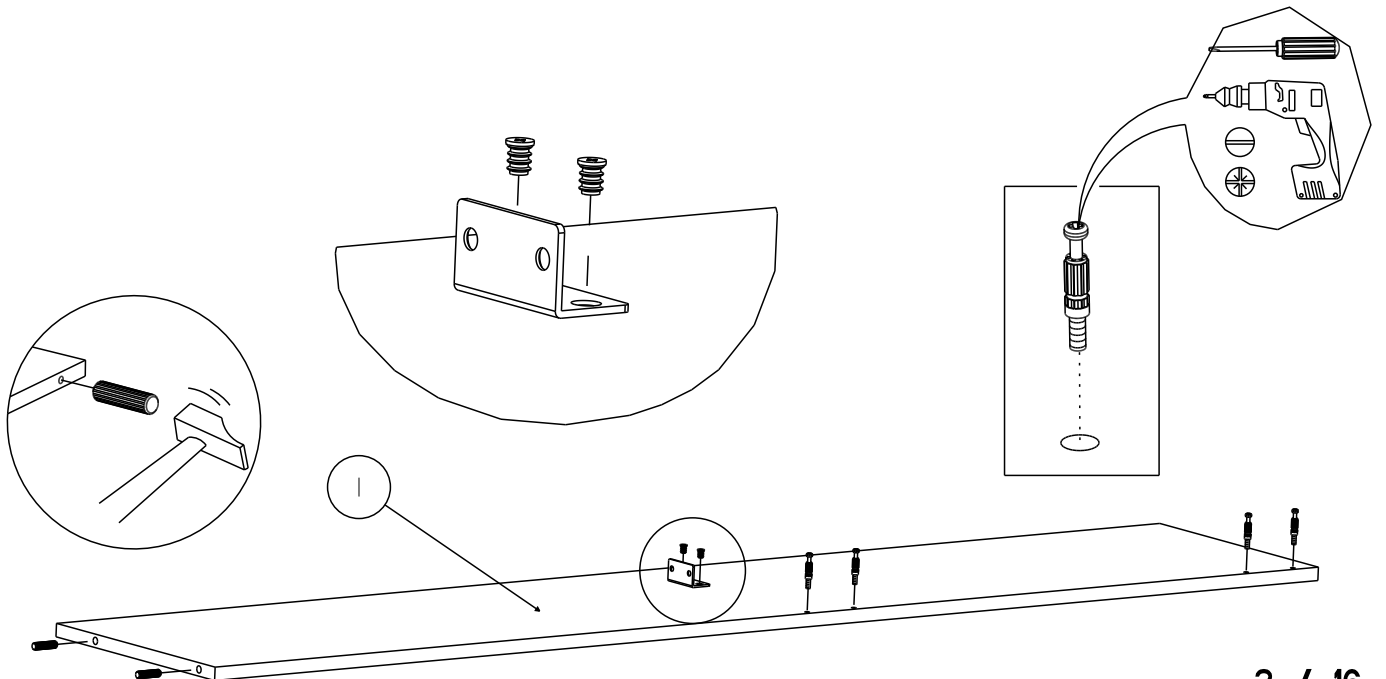
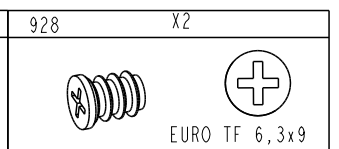
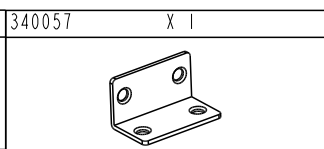
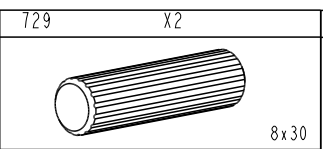
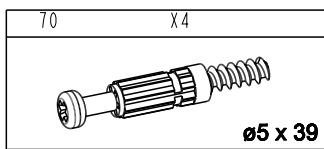

4

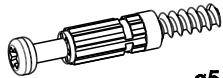
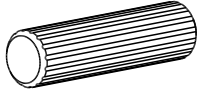
70	X4	729	X2
			
$\varnothing 5 \times 39$		8 x 30	

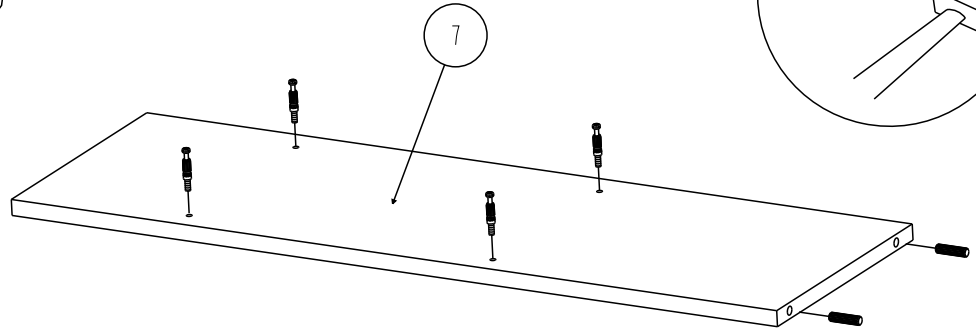
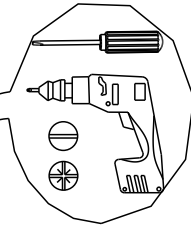
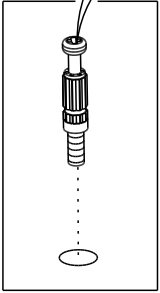
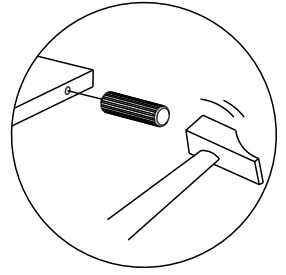

5

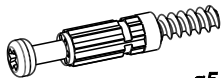
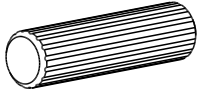
70	X2	729	X2
			
$\varnothing 5 \times 39$		8 x 30	

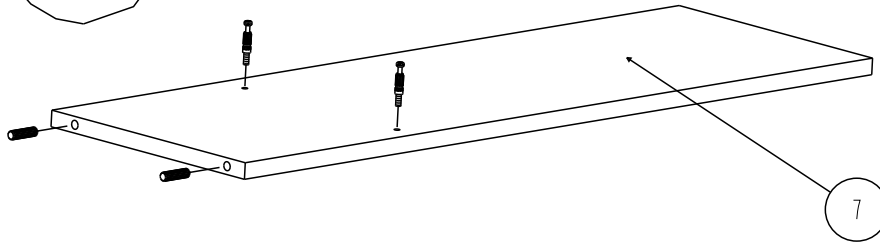
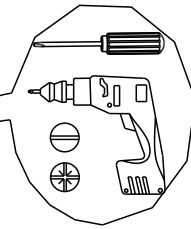
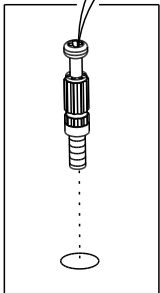
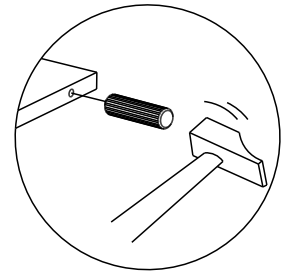

6

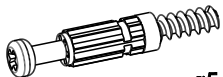
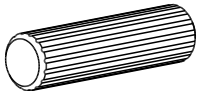
70	X4	729	X2
			
$\varnothing 5 \times 39$		8 x 30	

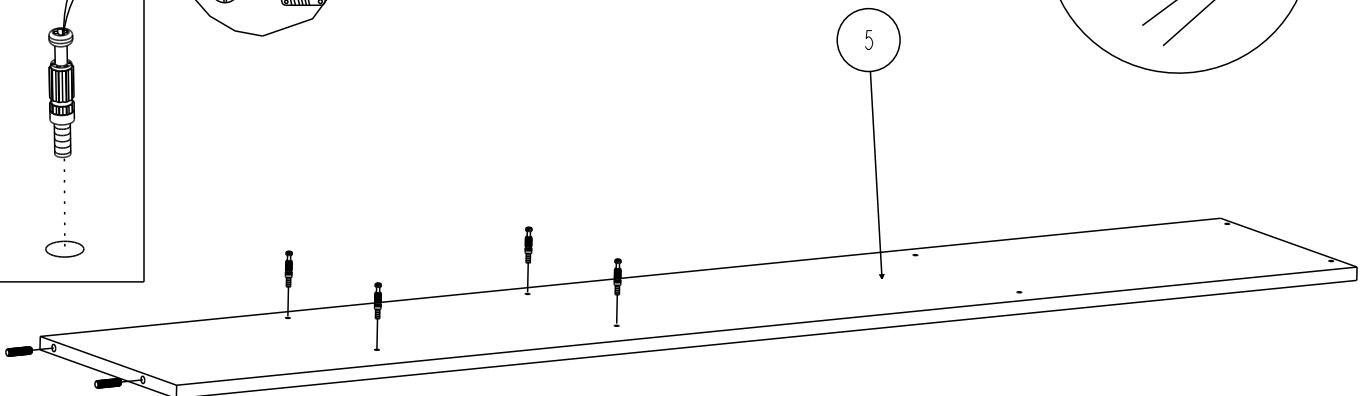
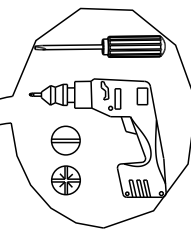
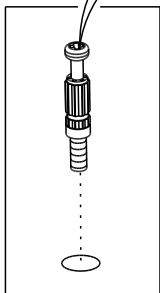
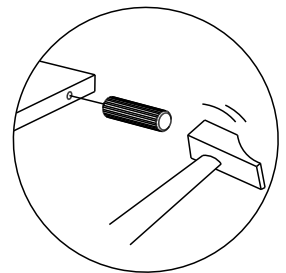

7

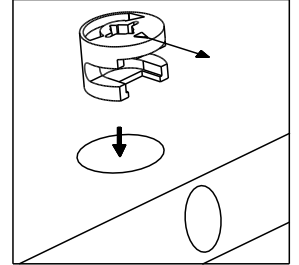
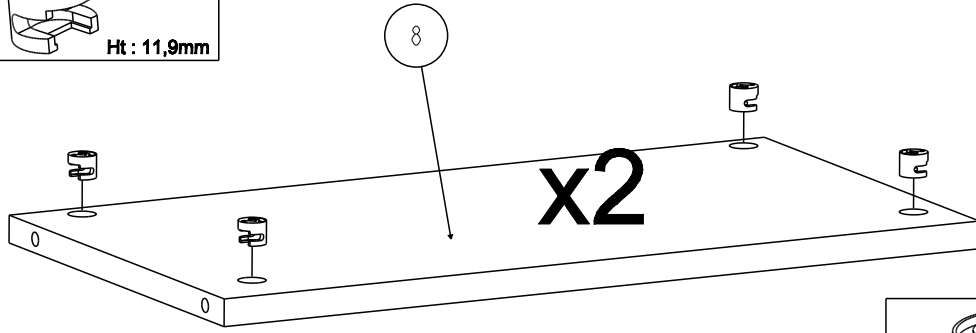
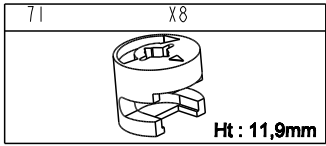

8

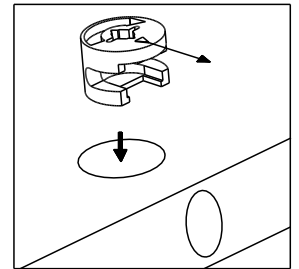
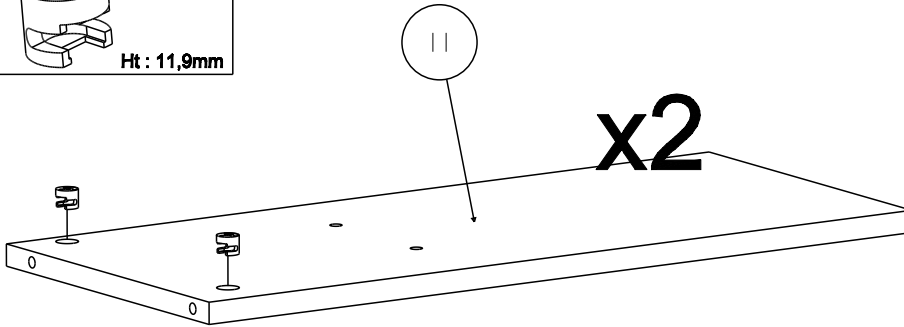
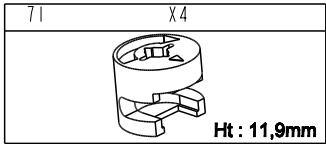

9

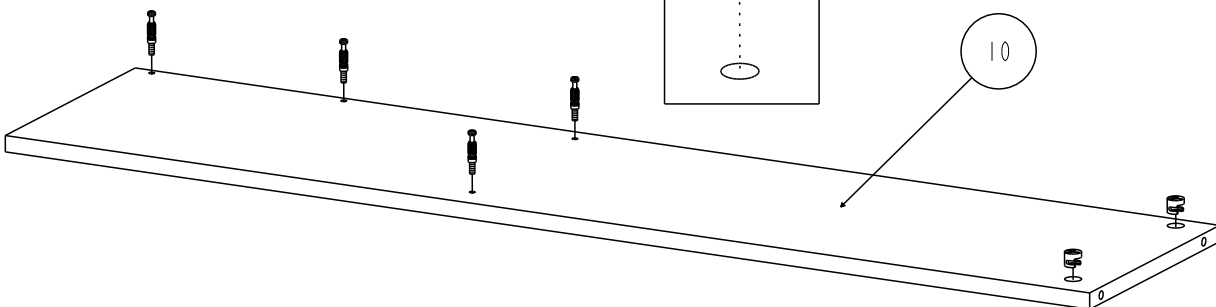
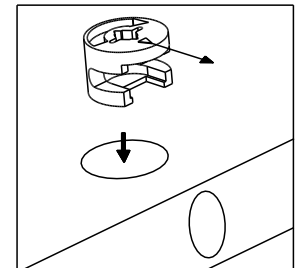
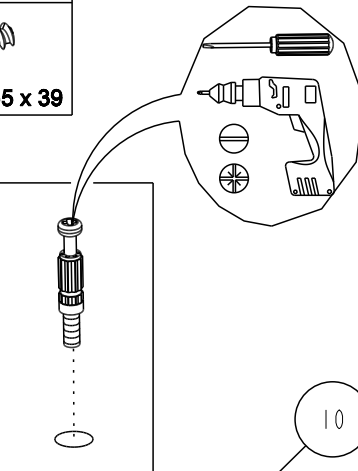
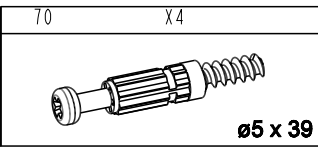
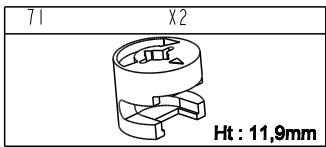

10

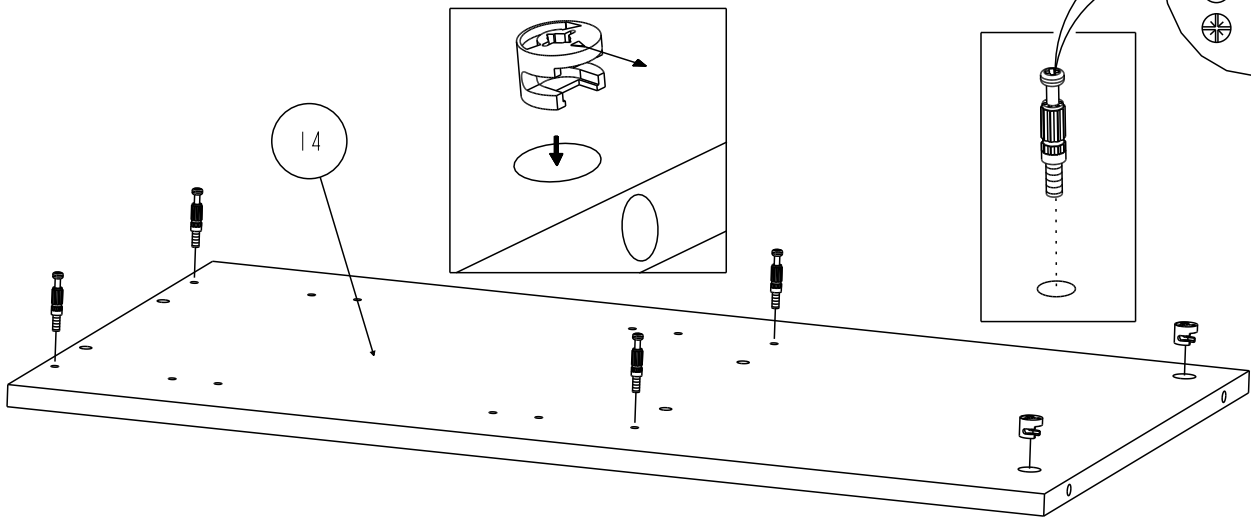
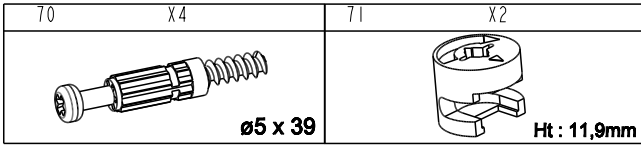

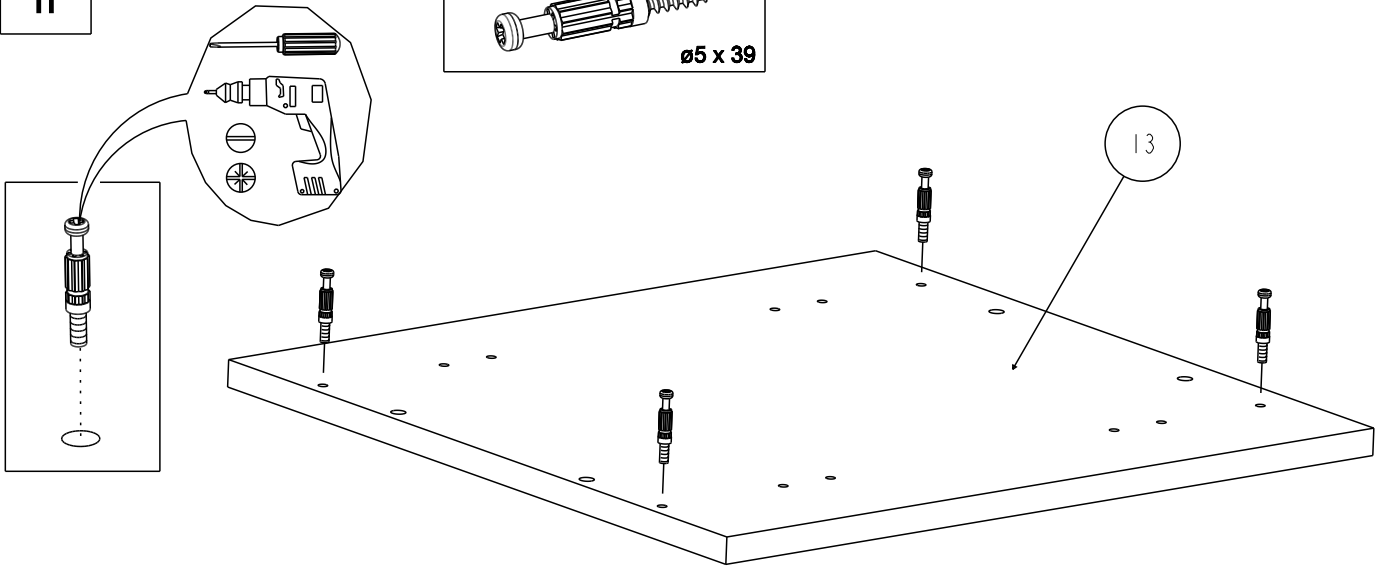
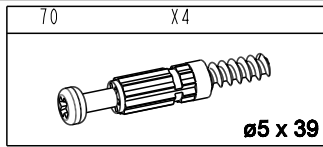

11

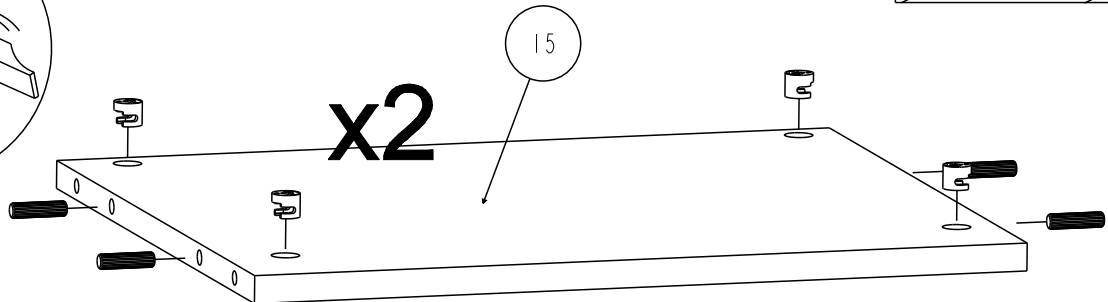
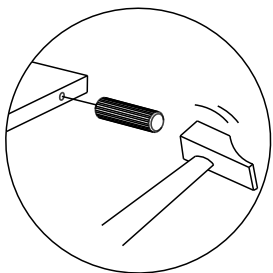
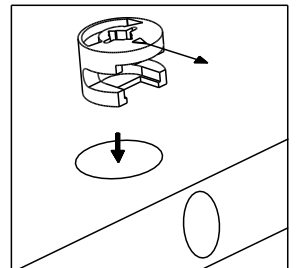
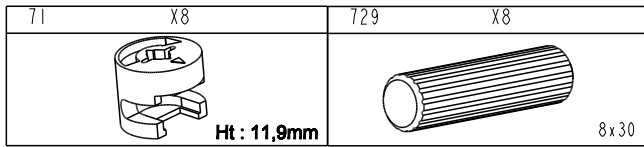

12

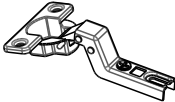

13

333010	X 2	949	X4
		  VBA TF 3.5x15	

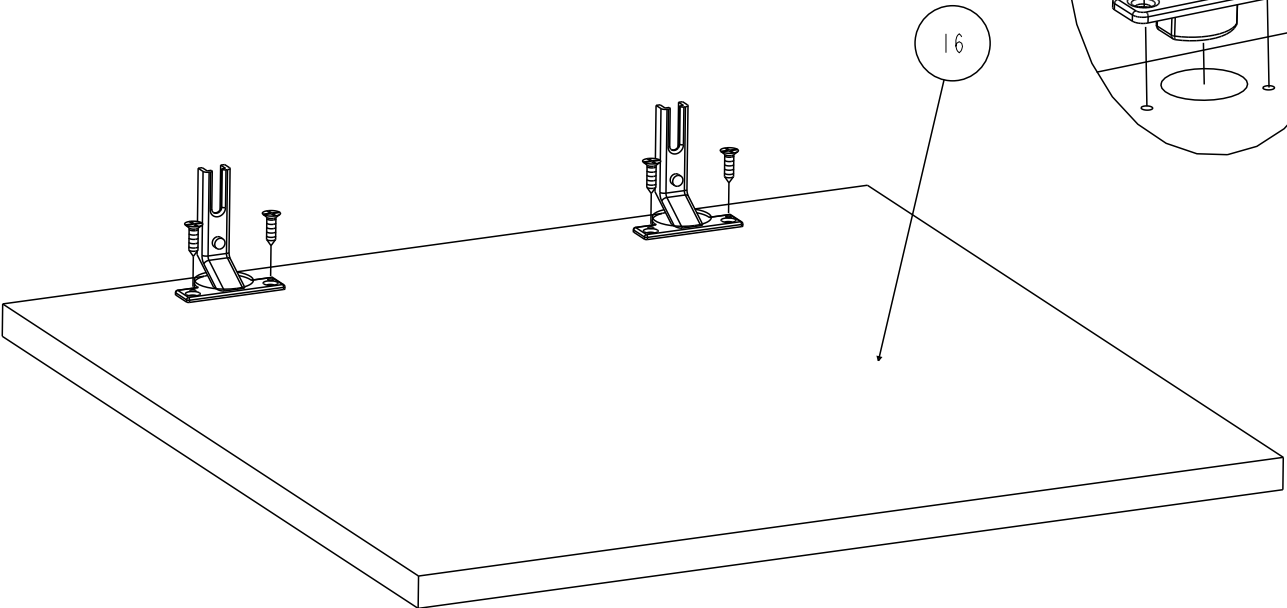
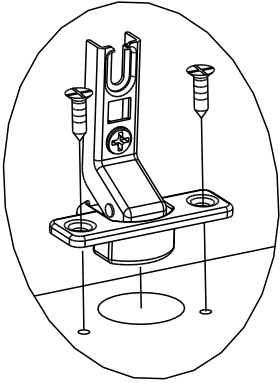



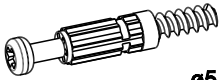

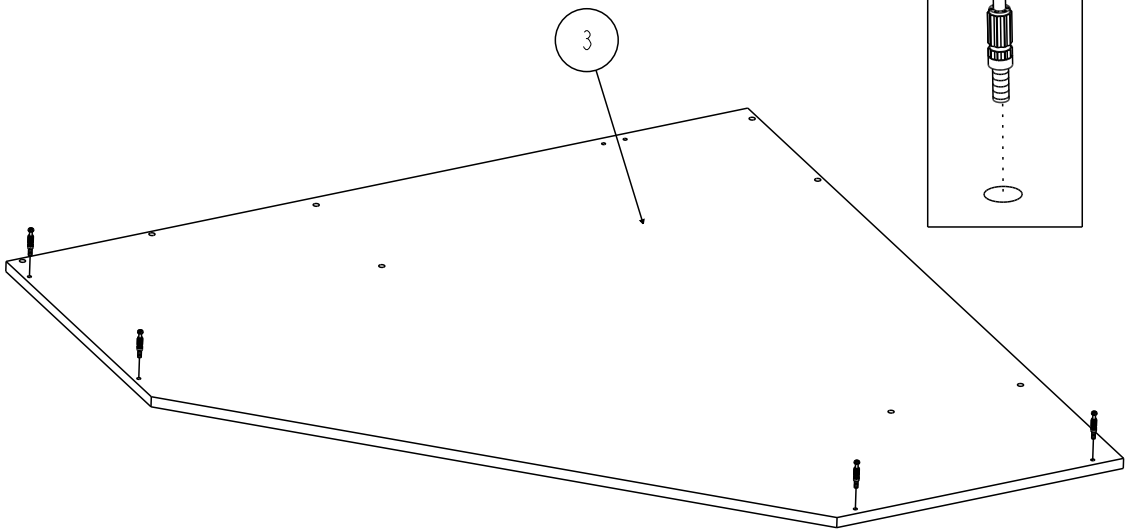
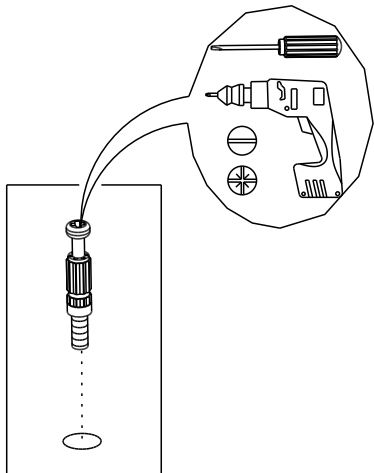
14

70	X4
	
ø5 x 39	

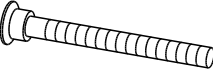

15

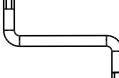
928	X2	340750	X 2	434	X1
					
EURO TF 6,3x9		6 PANS 7x50			

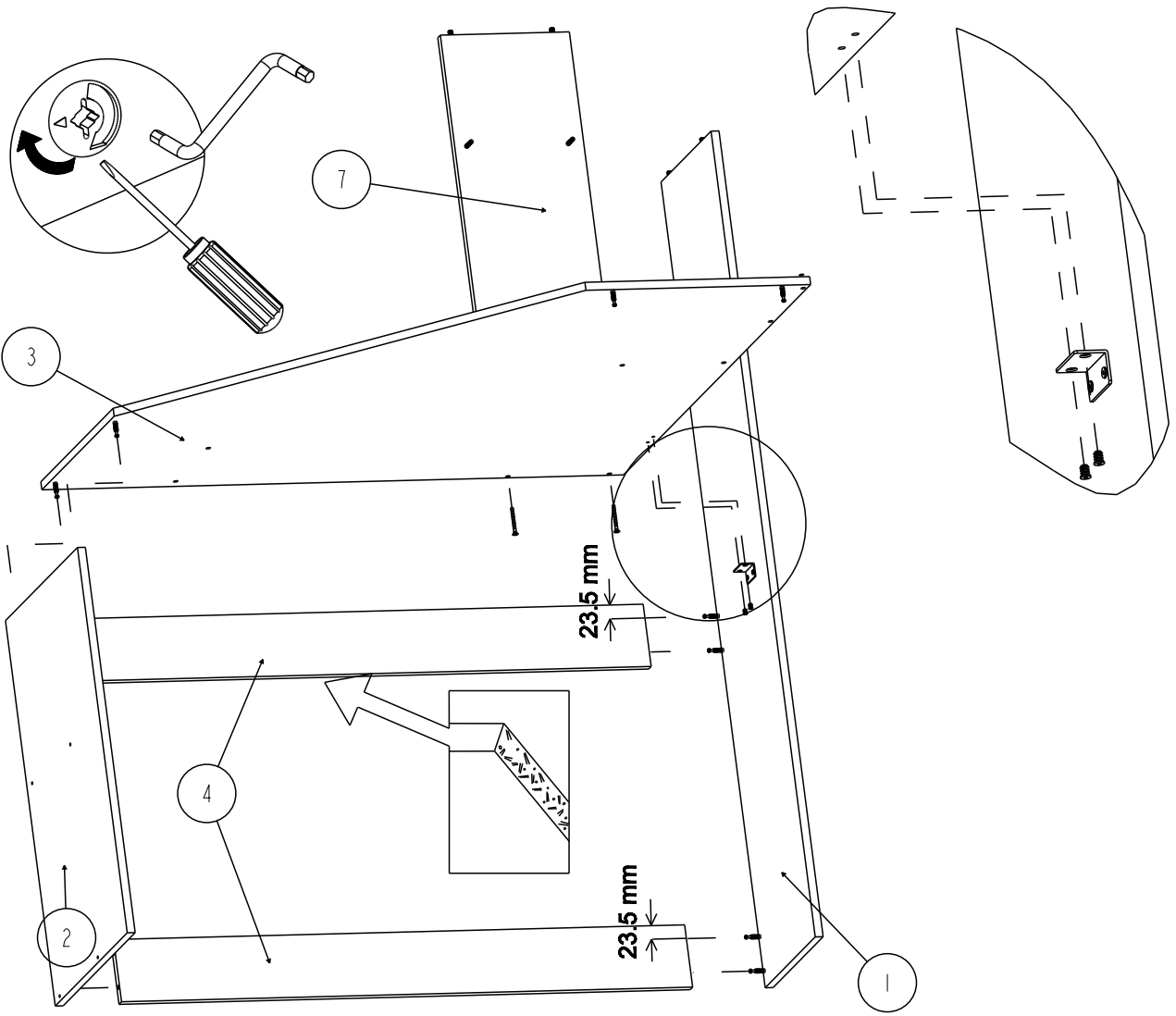

A

OU/OR

B

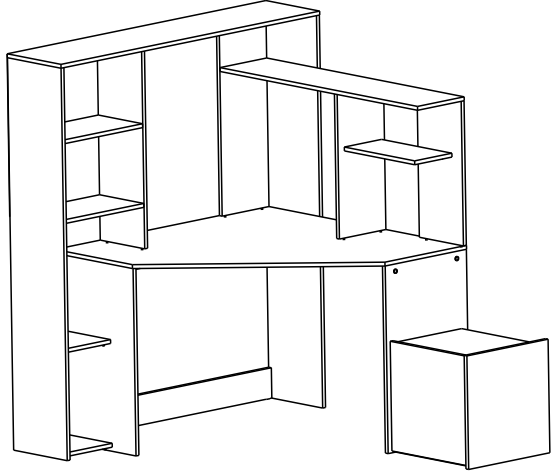
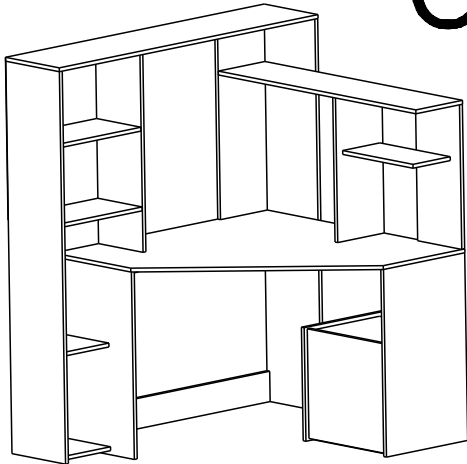

16

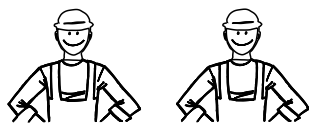
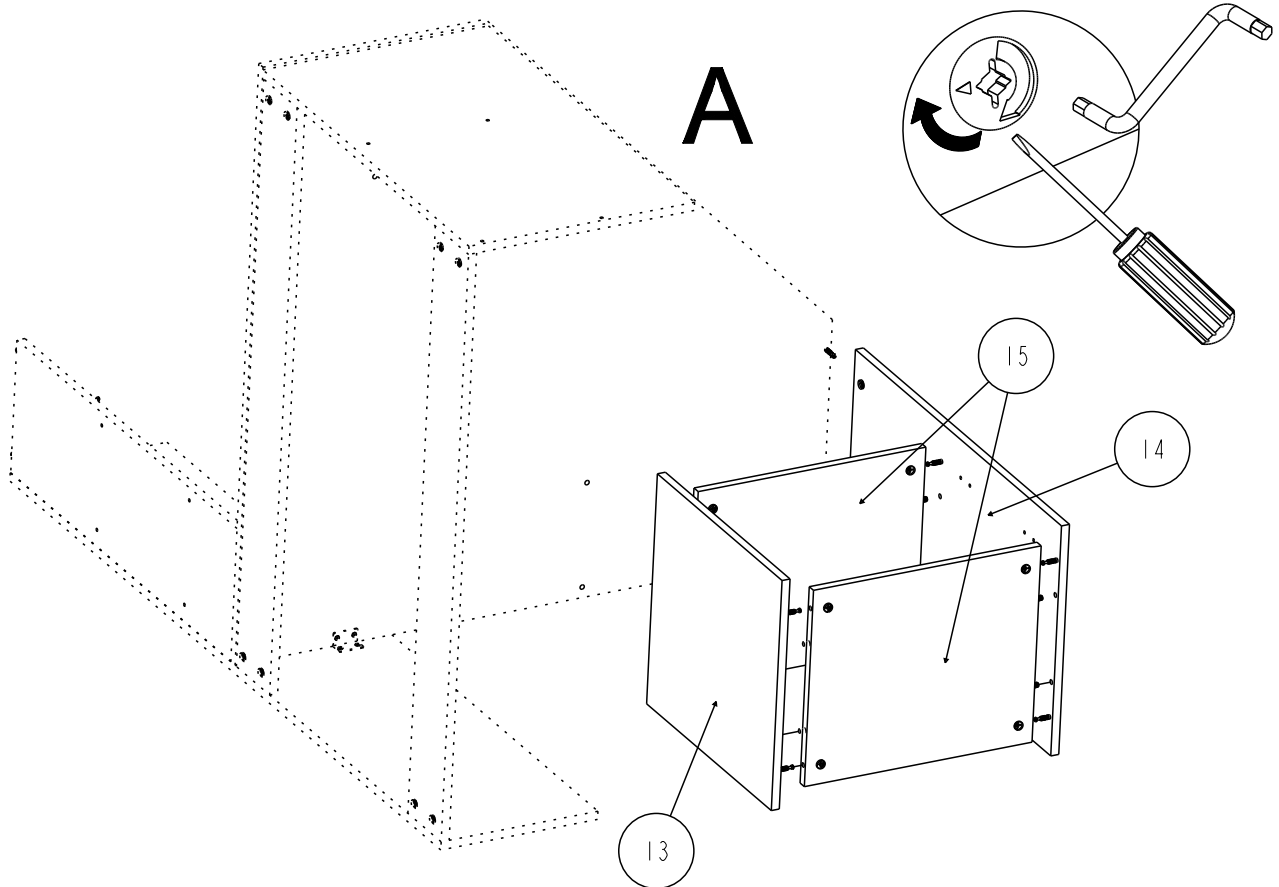

OU/OR

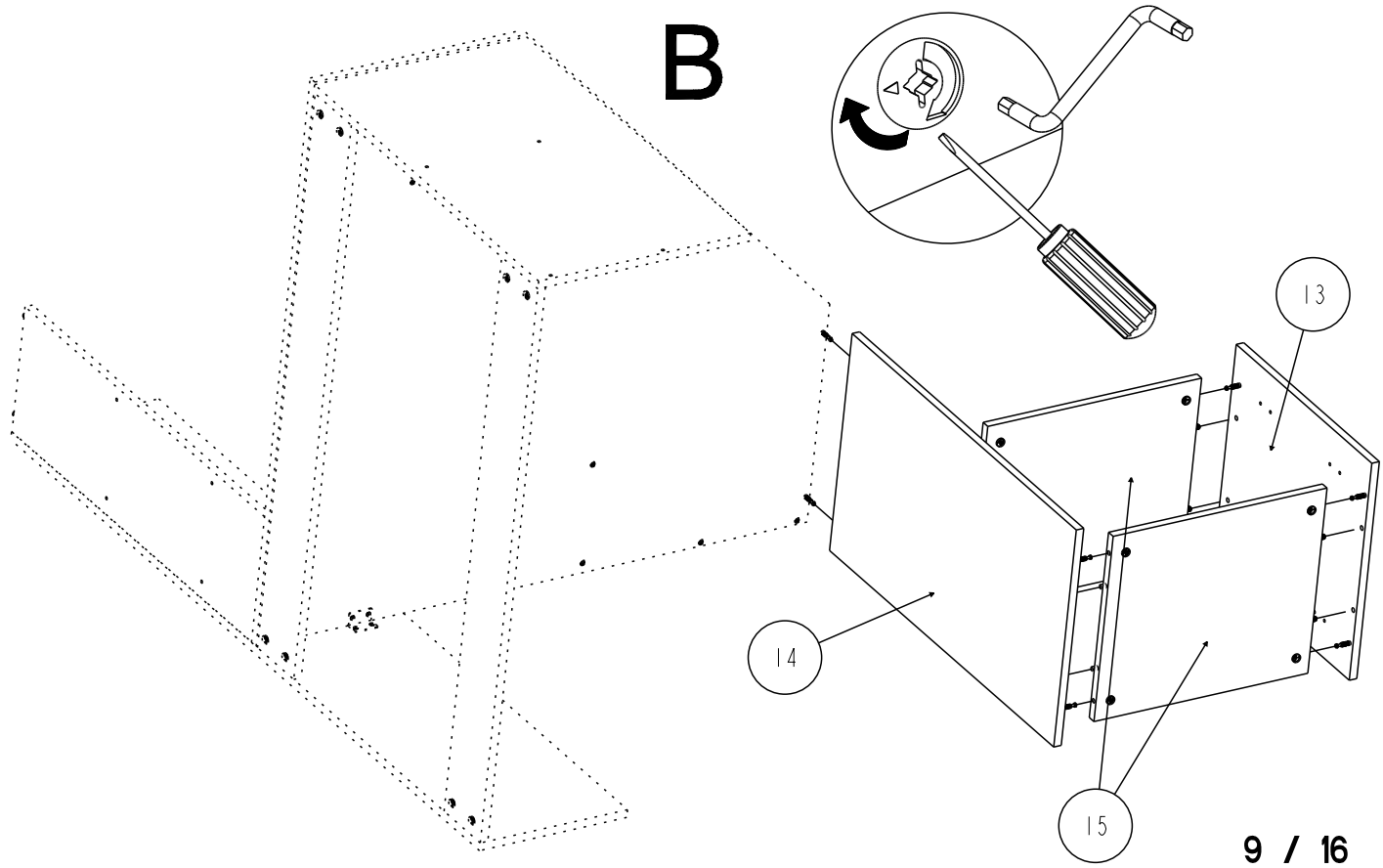
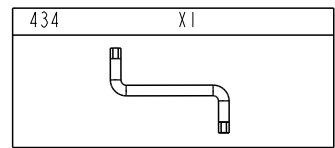

17

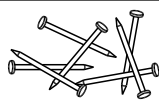
604757	X 1
	x30

331144	X 1
	

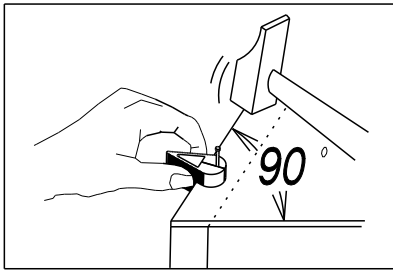

17

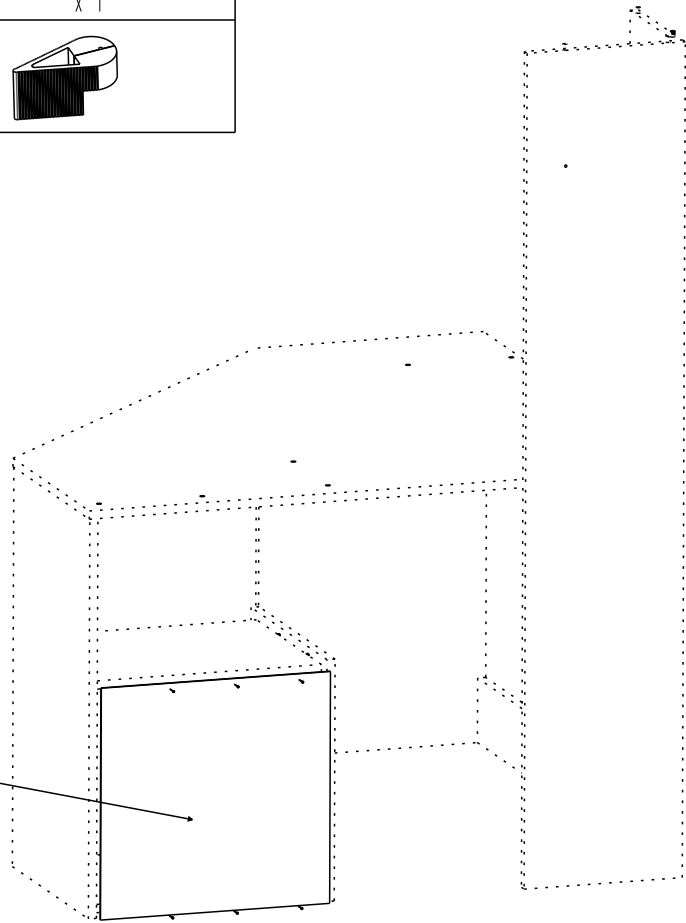

18

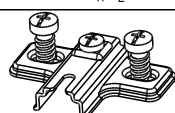
333009	X 2
	

A

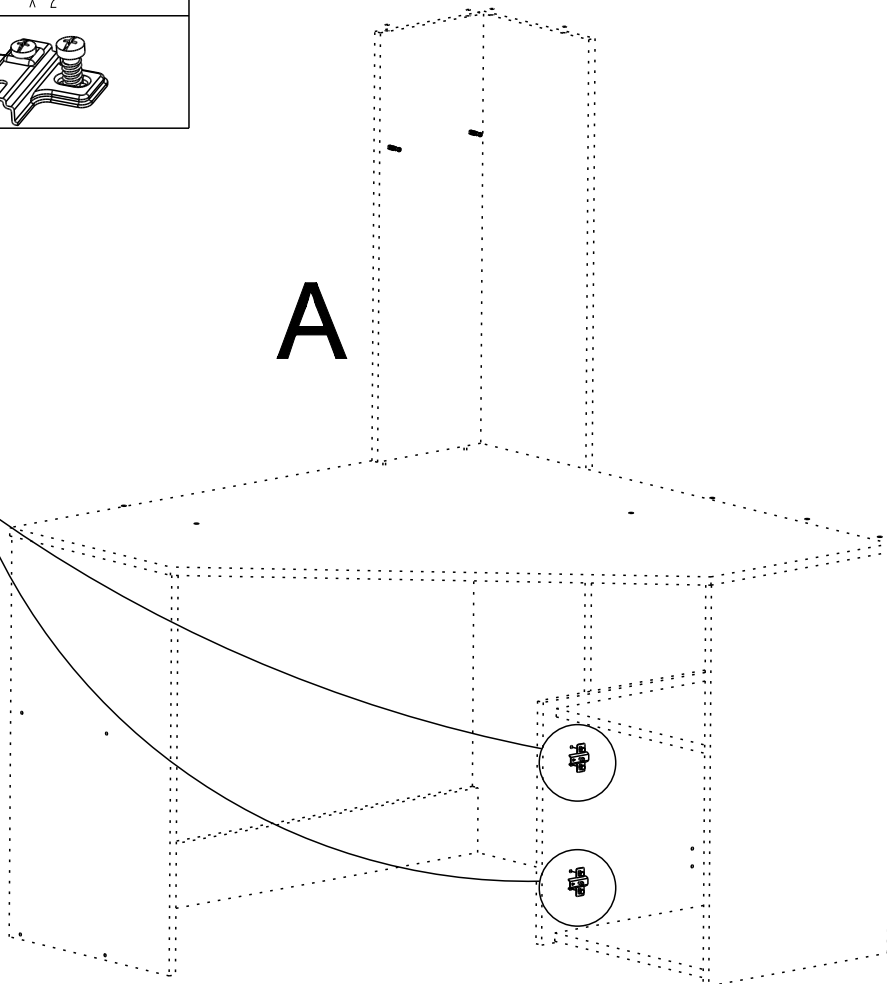
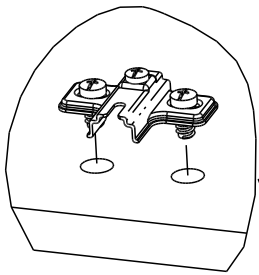

19

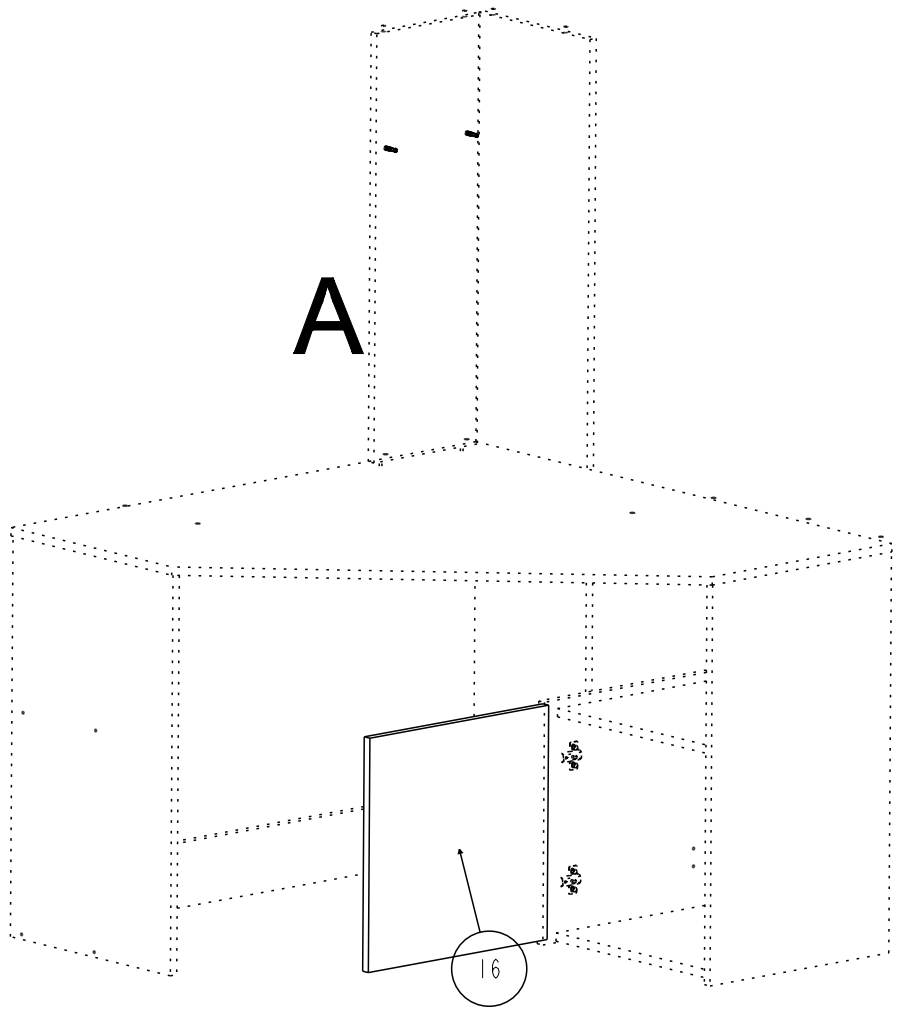
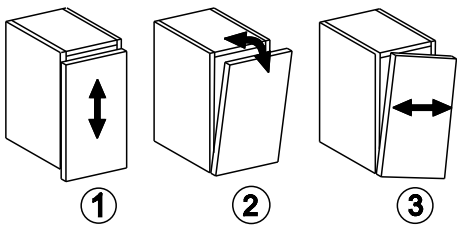
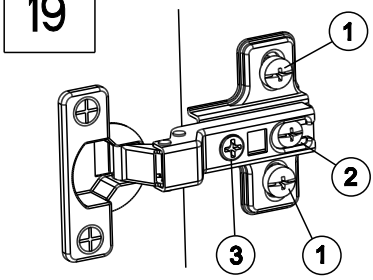

20

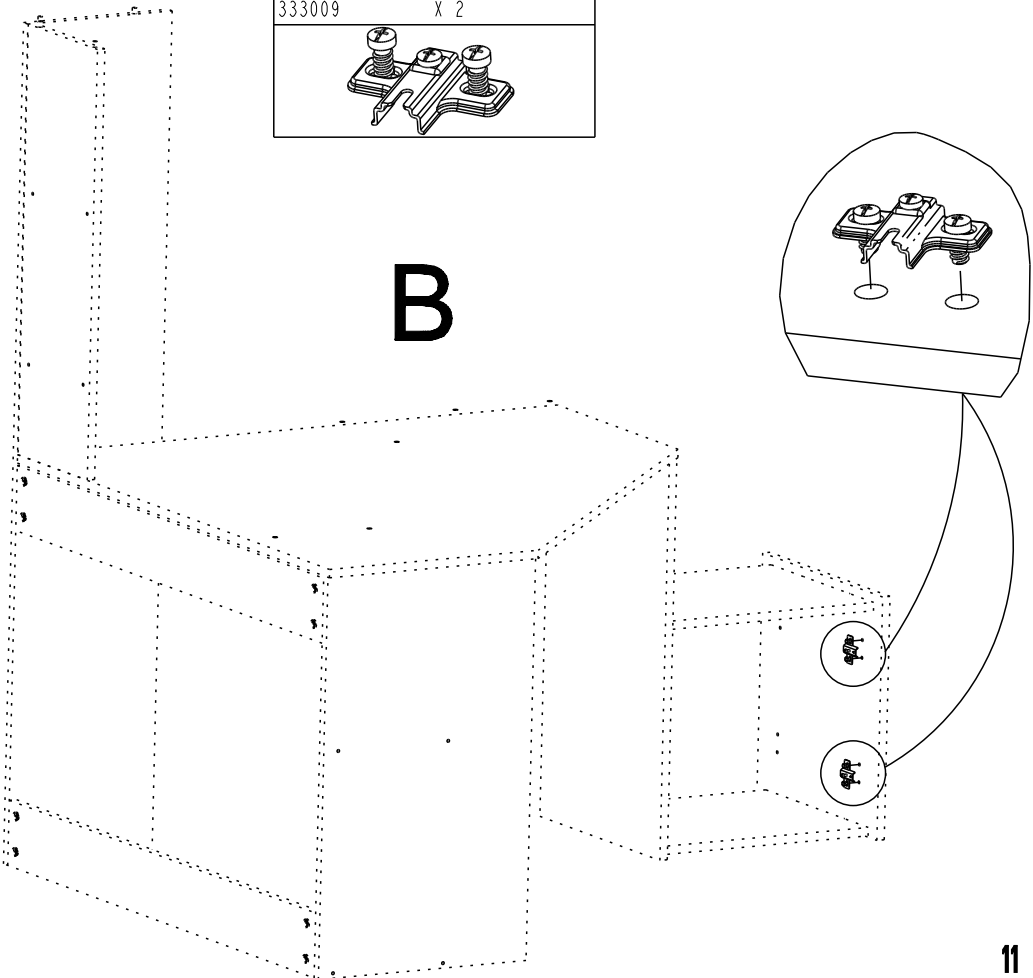
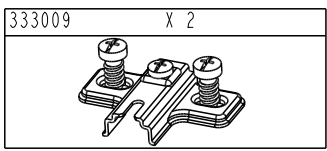

21

B

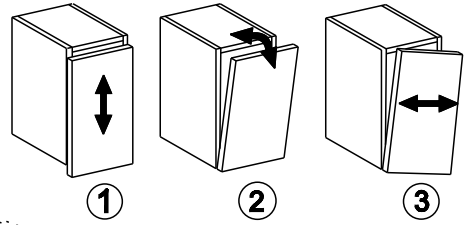
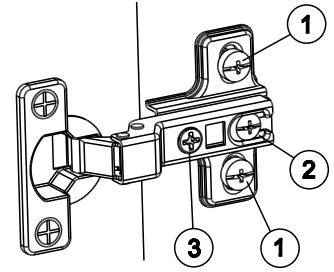
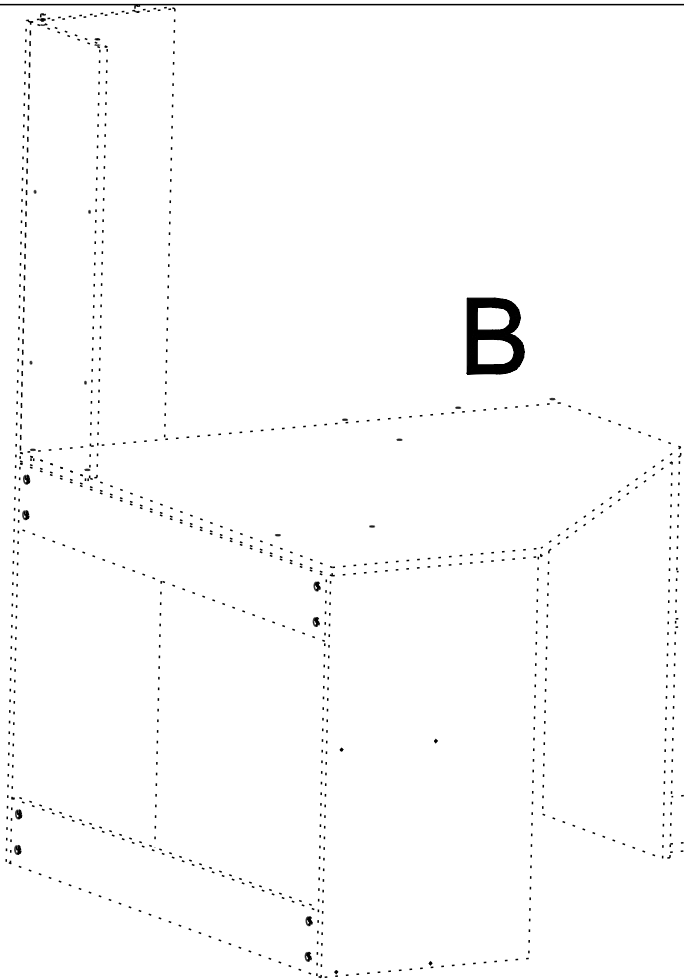

16

22

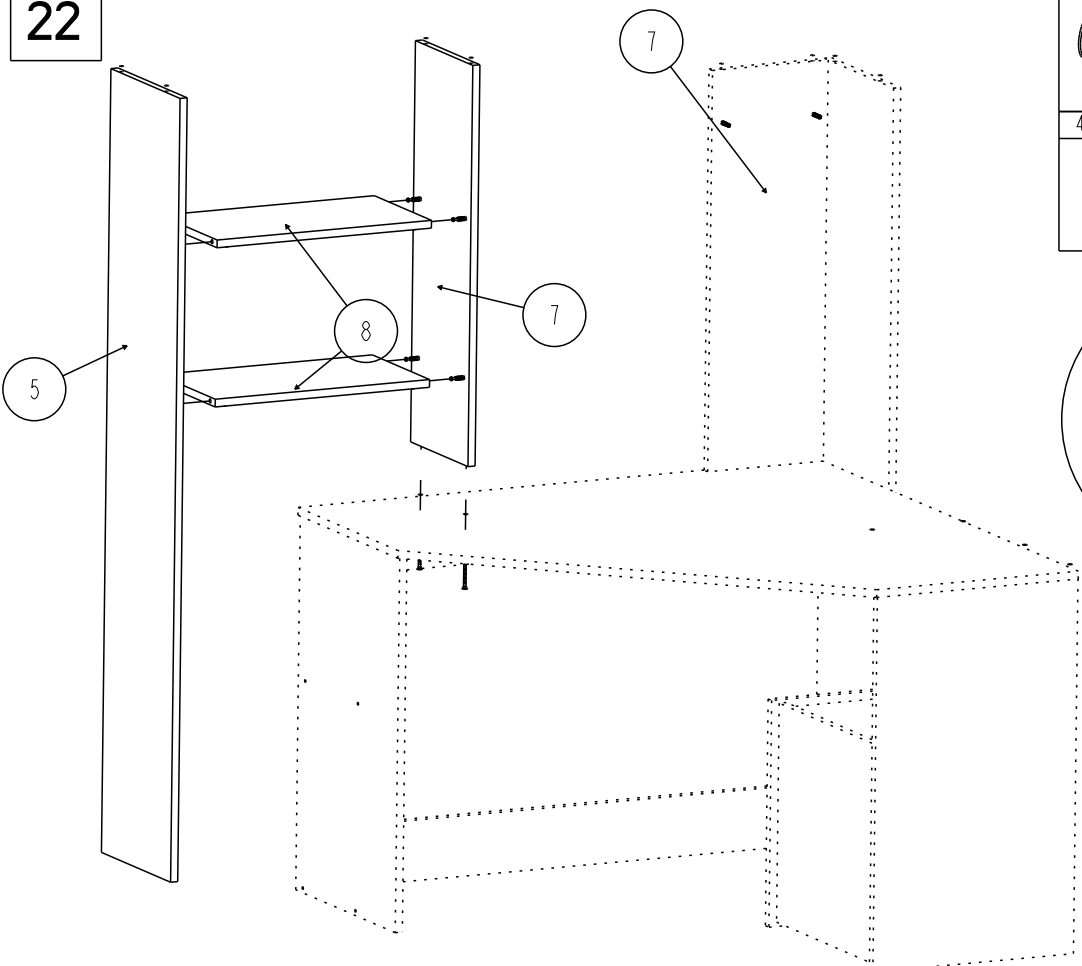

340750	X 2
6 PANS 7x50	
434	X 1

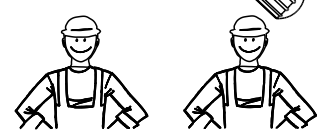
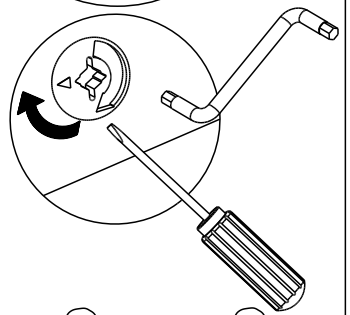
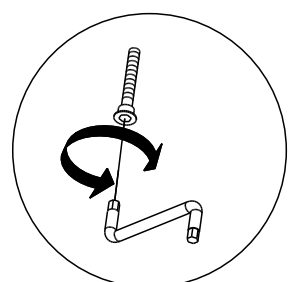

23

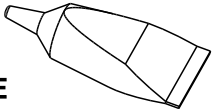

6

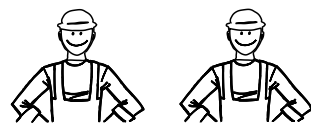
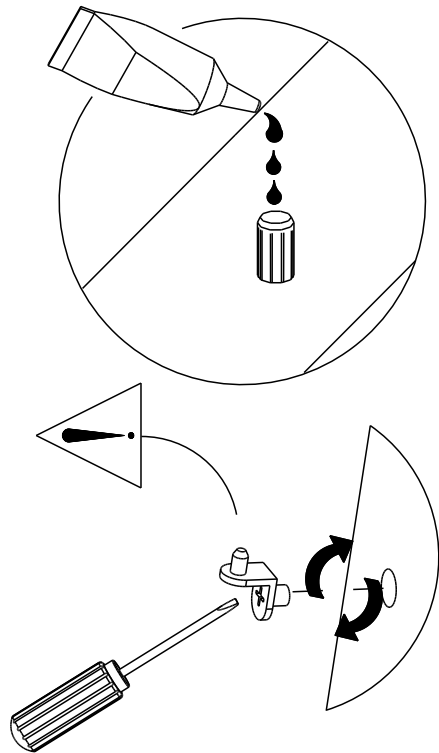
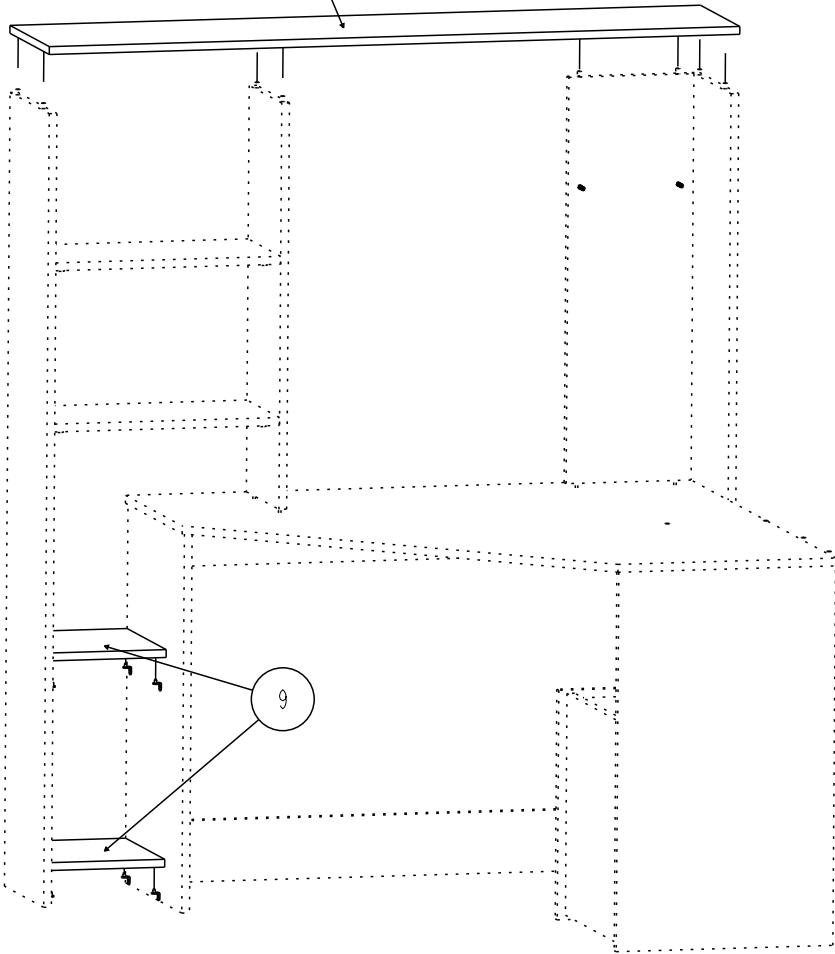
720	X 8	732	X 1
			
		GLUE	

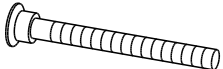

24

11

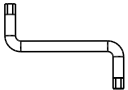
340750	X 4		
6 PANS 7x50			
434	X 1		

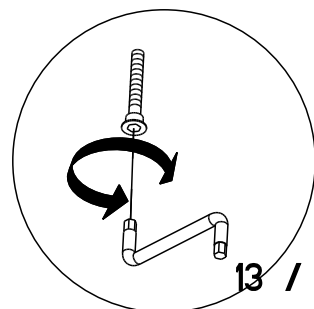
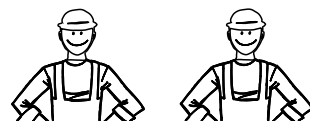
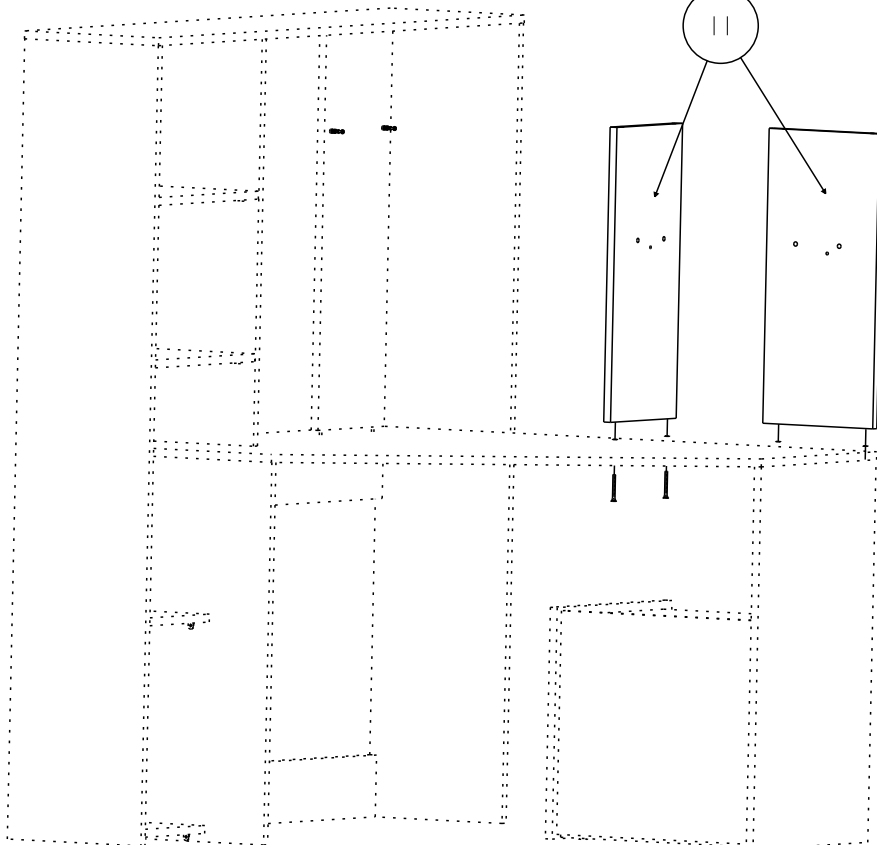

25

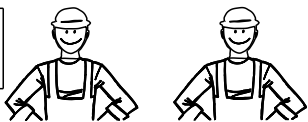

434	X1	340750	X 2	720	X 1
		6 PANS 7x50			

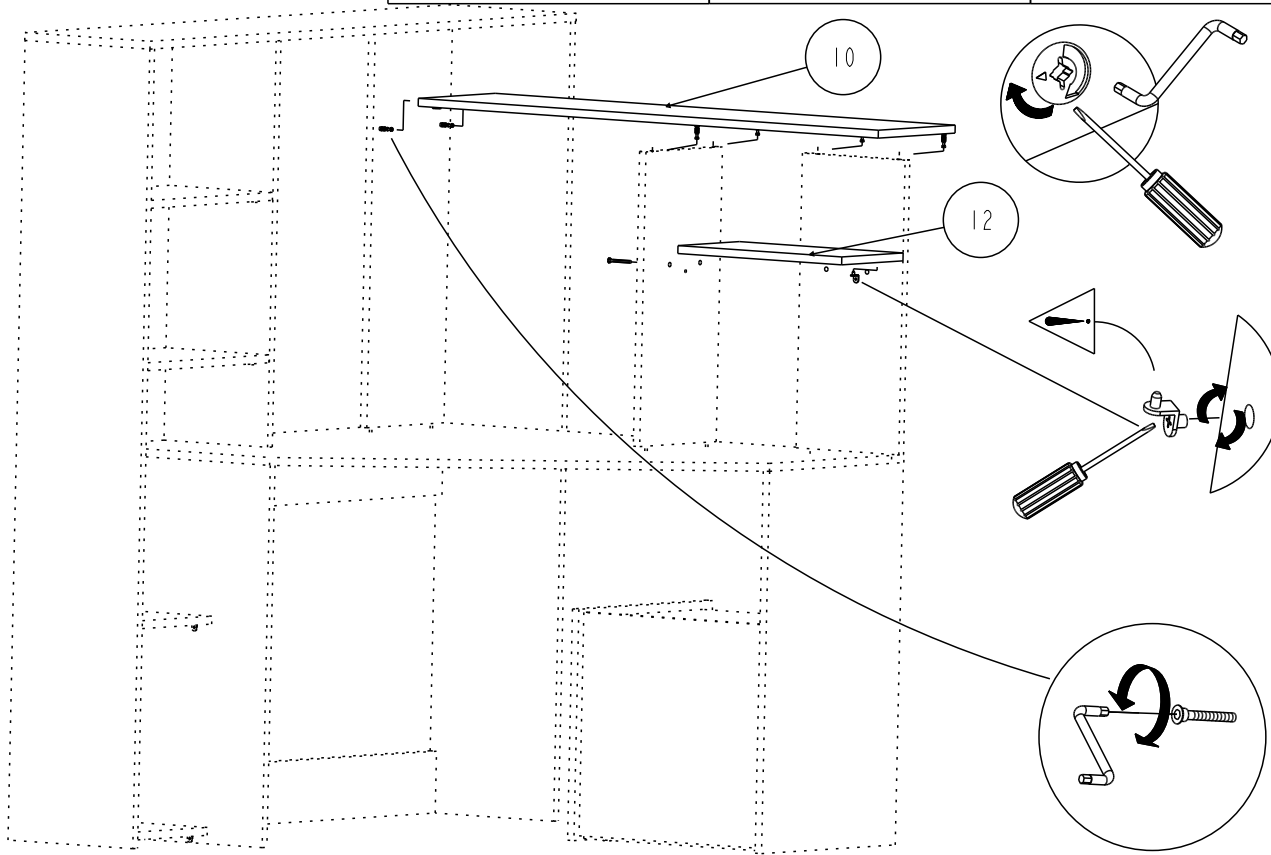

26

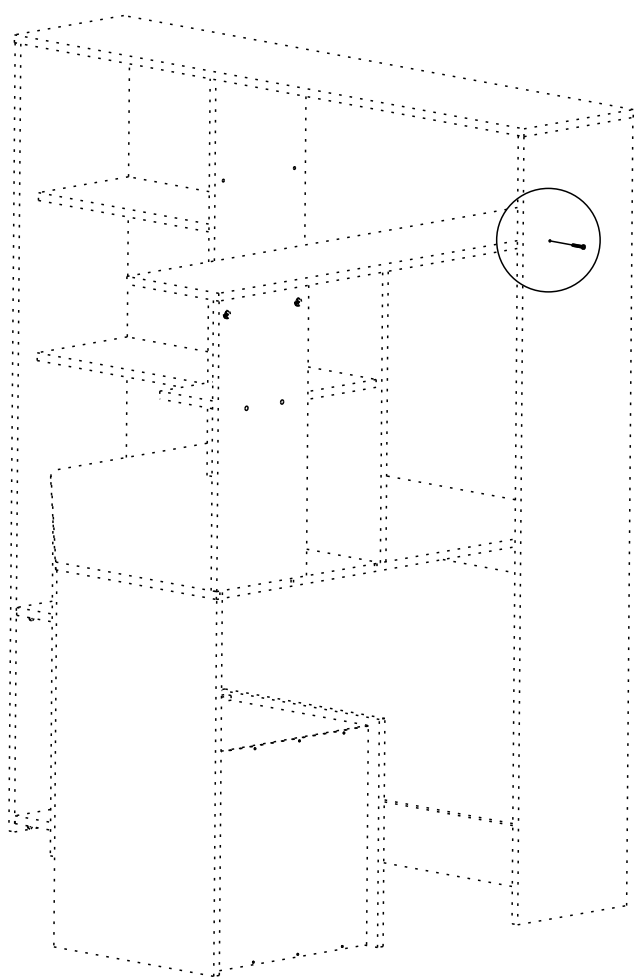

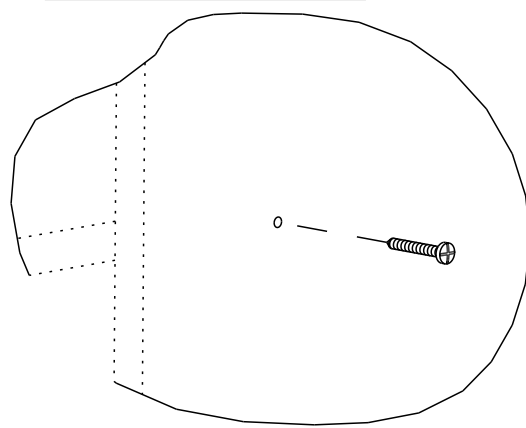

340077	X 3	340042	X 18
	ø5mm Ht: 6mm		

913	X1
	VBA TR 4x30



27

331144	X 1
	
604757	X 1
	x30

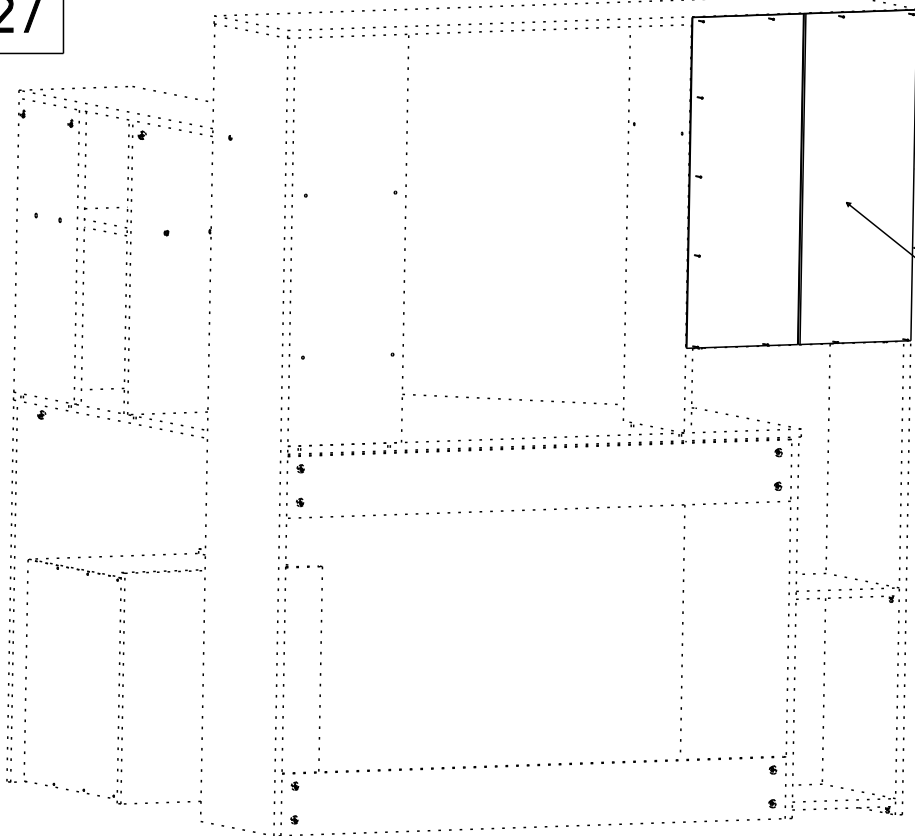

18

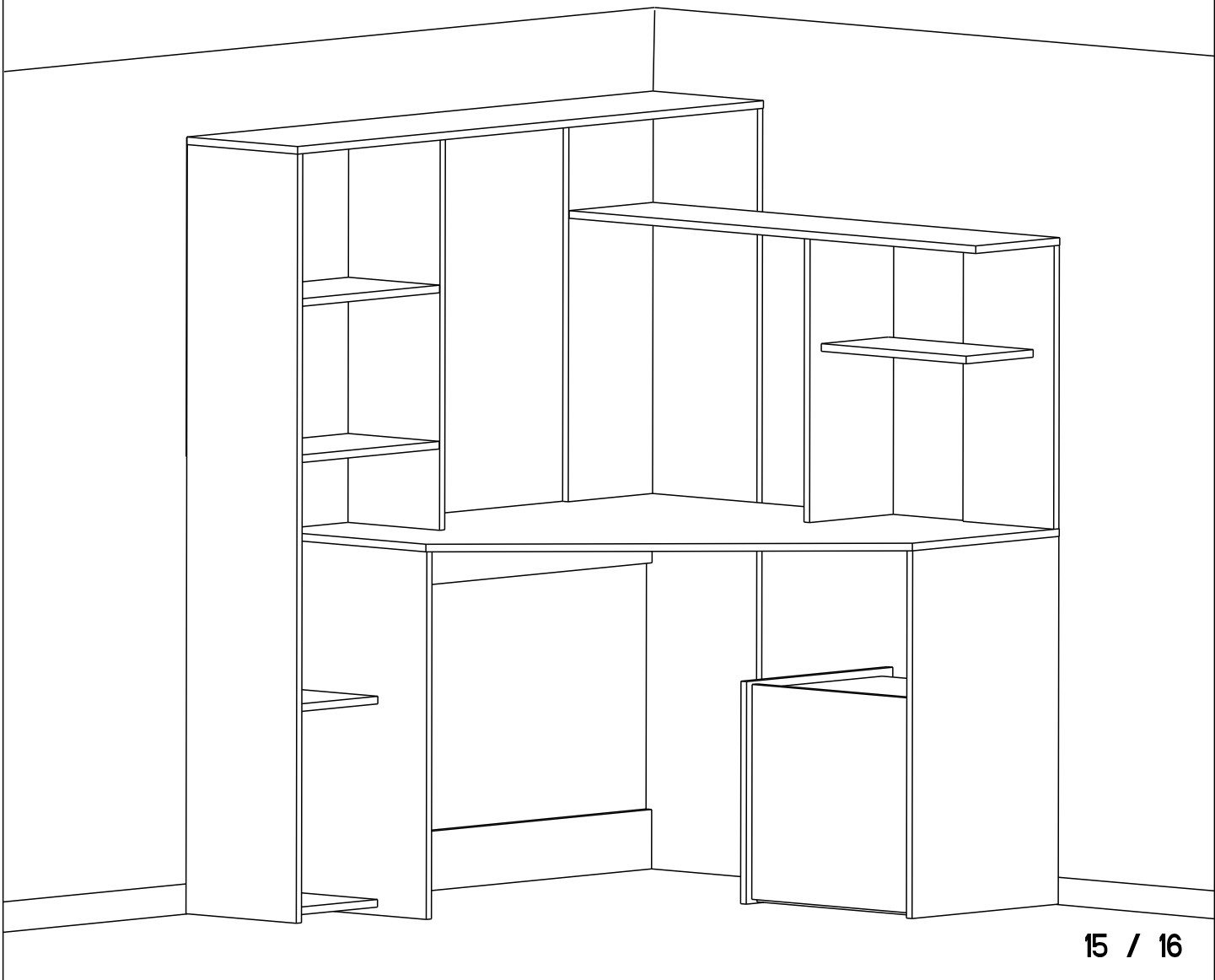
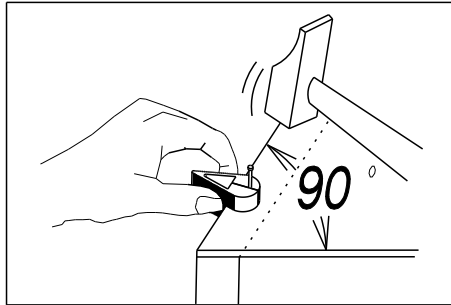

FR ATTENTION CE PRODUIT DOIT ETRE
DISPOSE ET UTILISE LE LONG DE 2 MURS
PERPENDICULAIRES

ES CUIDADO ESTE PRODUCTO TIENE QUE
SER PUESTO E UTILIZADO ENTRE 2 MUROS
PERPENDICULARES

PT ATENÇÃO ESTE PRODUTO DEVE SER
COLOCADO E UTILIZADO AO LONGO DE DUAS
PAREDES PERPENDICULARES

EN BE CAREFUL THIS PRODUCT MUST BE
PUT AND USED ALONG 2 PERPENDICULAR
WALLS

IT ATTENZIONE QUESTO PRODOTTO DEVE
ESSERE DISPOSTO E UTILIZZATO FRA 2 MURI
PERPENDICOLARI

NL AANDACHT DIT PRODUCT MOET TUSSEN
TWEЕ HOEKVORMIGE WANDEN GEPLAATS
WORDEN

PL UWAGA TEN PRODUKT MUSI BYĆ GOTOWI I
UŻYWANE WRAAZ 2 PROSTOPADLYCH ŚCIAN

DE ACHTUNG DIESES PRODUKT MUSS IN
EINER ECKE AUFGESTELLT UND BENUTZT
WERDEN