

ENFILADE

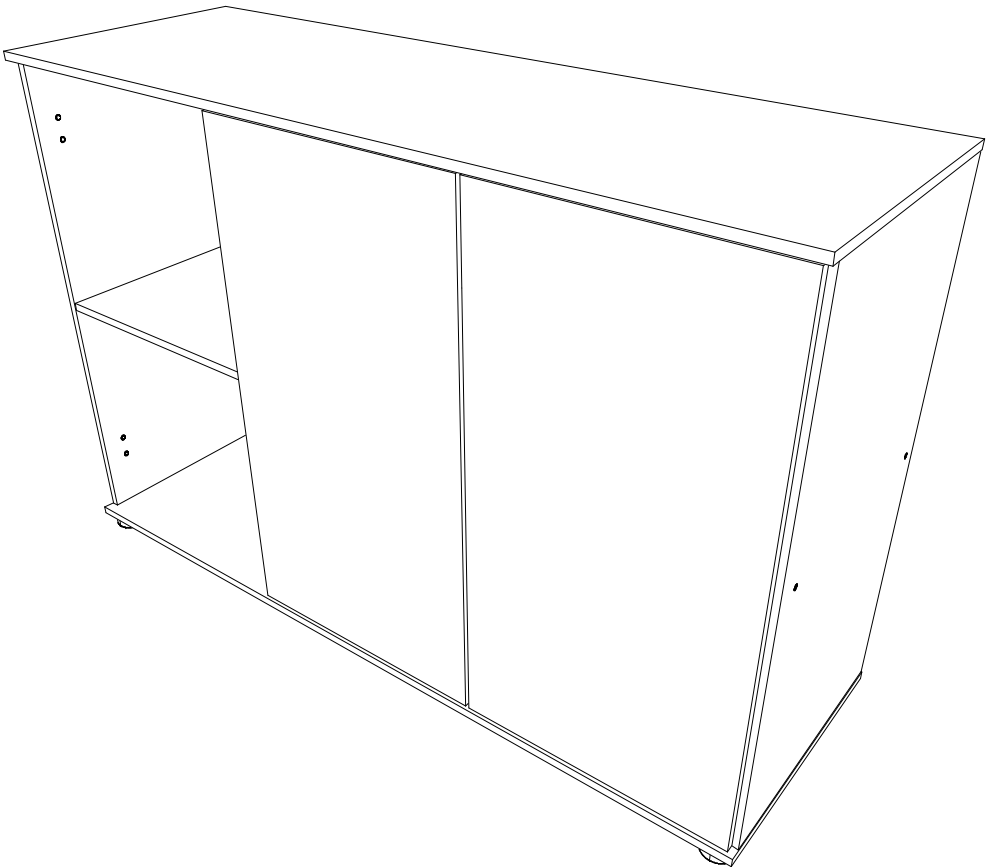

FR Remerciements :

Nous vous remercions d'avoir choisi un meuble créé et fabriqué par le Groupe Parisot et espérons qu'il vous donnera entière satisfaction.

EN Thanks:

Thank you for choosing furniture designed and manufactured by the Parisot Group. We hope you are totally satisfied with your purchase.

DE Danksagung:

Wir danken Ihnen für den Kauf eines Frankreich von der Parisot-Gruppe entworfenen und hergestellten Möbelstücks und hoffen, dass Sie es zu Ihrer vollkommenen Zufriedenheit finden werden.

ES Agradecimientos:

Les damos las gracias por haber elegido un mueble diseñado y fabricado por el Groupe Parisot y esperamos que sea de su total agrado.

PT Agradecimentos:

Obrigado por ter escolhido um móvel concebido e fabricado pelo Grupo Parisot, esperando que seja do seu inteiro agrado.

IT Ringraziamenti:

Grazie per avere scelto un mobile progettato e fabbricato dal Gruppo Parisot. Speriamo soddisfatti appieno le vostre esigenze.

NL Bedankje:

Wij bedanken u voor de aankoop van een door de Groep Parisot ontworpen en vervaardigd meubel en hopen dat u er veel plezier aan zult beleven.

CZ Poděkování:

Děkujeme, že jste si vybrali nábytek navržený a vyrobený společností Parisot Group. Doufáme, že budete svým nákupem naprosto spokojeni.

HU Köszönet.

Köszönjük, hogy a Parisot Groupe által létrehozott és gyártott bútort választott, reméljük, hogy elégedett lesz a termékkel.

PL Podziękowania:

Dziękujemy za wybór mebli stworzonych i wyprodukowanych przez Grupę Parisot. Mamy nadzieję, że będziecie Państwo w pełni zadowoleni z zakupu.

RO Mulțumiri:

Vă mulțumim că ați ales un articol de mobilier conceput și fabricat de Grupul Parisot și sperăm că veți fi pe deplin satisfăcuți de acesta.

RU Благодарность:

Мы благодарим вас за то, что вы выбрали мебель, созданную и произведенную Групп Паризо, и надеемся, что вы будете полностью довольны нашей продукцией.

SK Pod'akovanie:

Ďakujeme, že ste si vybrali nábytok navrhnutý a vyrobený spoločnosťou Parisot Group. Dúfame, že budete svojím nákupom absolútne spokojní.

TR Teşekkür ederiz:

Parisot Group tarafından tasarlanan ve üretilen mobilyayı seçtiğiniz için teşekkür ederiz. Ürünümüzden memnun kalmanızı ümit ederiz.

AR شكر:

نشكركم لاختياركم هذه القطعة من الأثاث من تصميم وتصنيع مجموعة باريزو Parisot ونتمنى أن تتلوا رضاهكم.

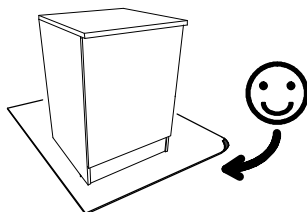
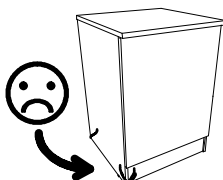
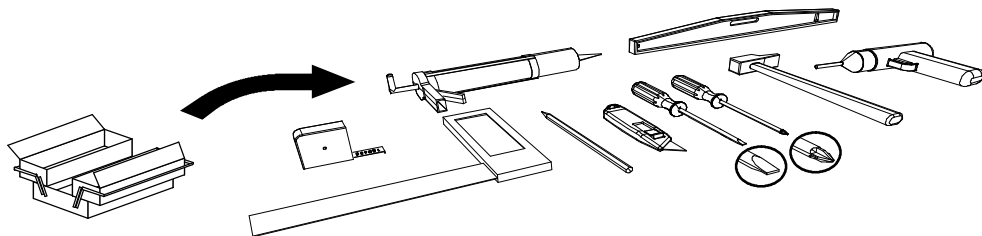

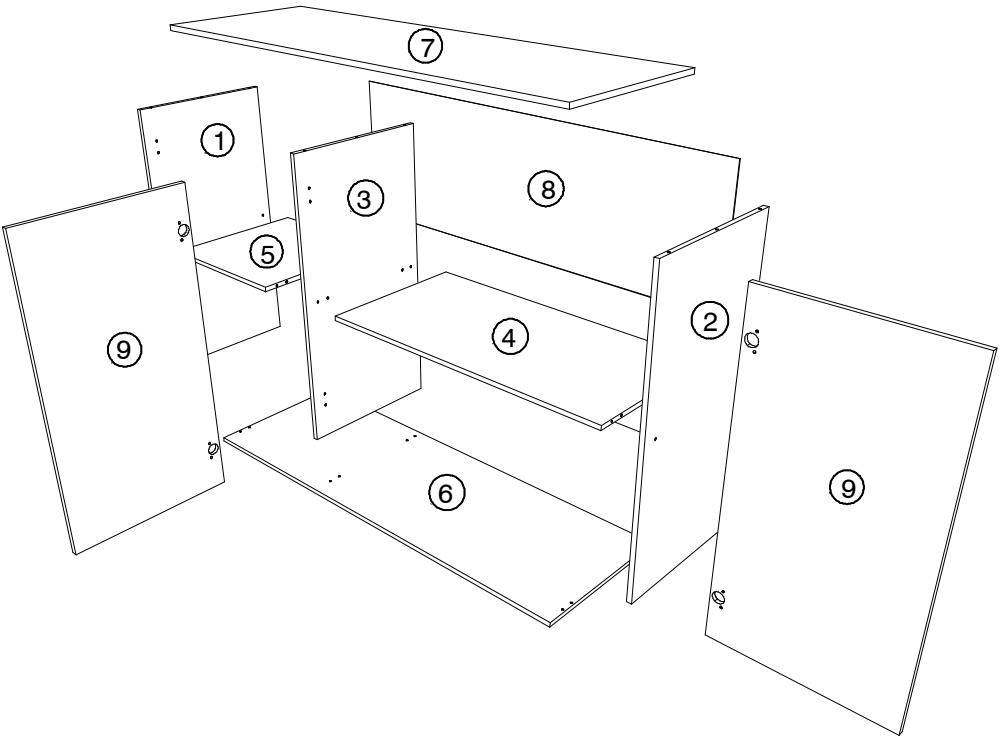

| | | | | | |
|------------|---|------|-----|---|---|
| | 0 | 1 cm | 2 | 3 | 4 |
| VG | | | x1 | | |
| AGN | | | x5 | | |
| ADU | | | x18 | | |
| VO3 | | | x12 | | |

| | | | | | |
|------------|--|----|------------|--|-----|
| PB | | x2 | CII | | x4 |
| CIJ | | x4 | BWX | | x4 |
| BWU | | x4 | HV | | x1 |
| OO | | x8 | PA | | x30 |
| BXC | | x5 | CF | | x1 |
| XB | | x1 | | | |

1

ADU



x8

CIJ

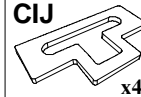

x4

BWU

x4

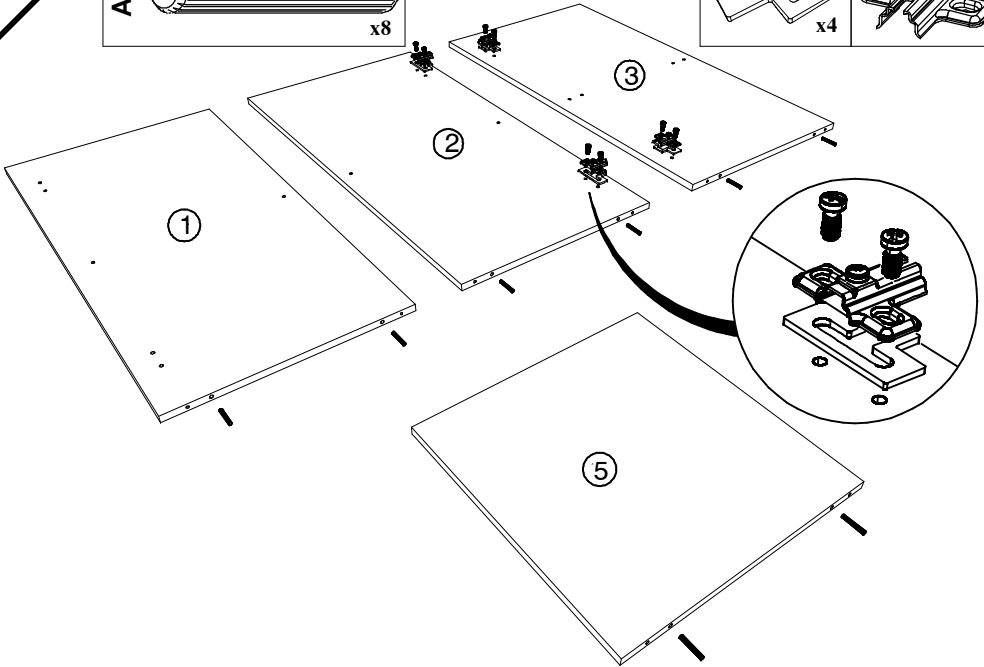
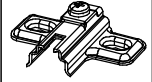

2

VO3



x4

HV

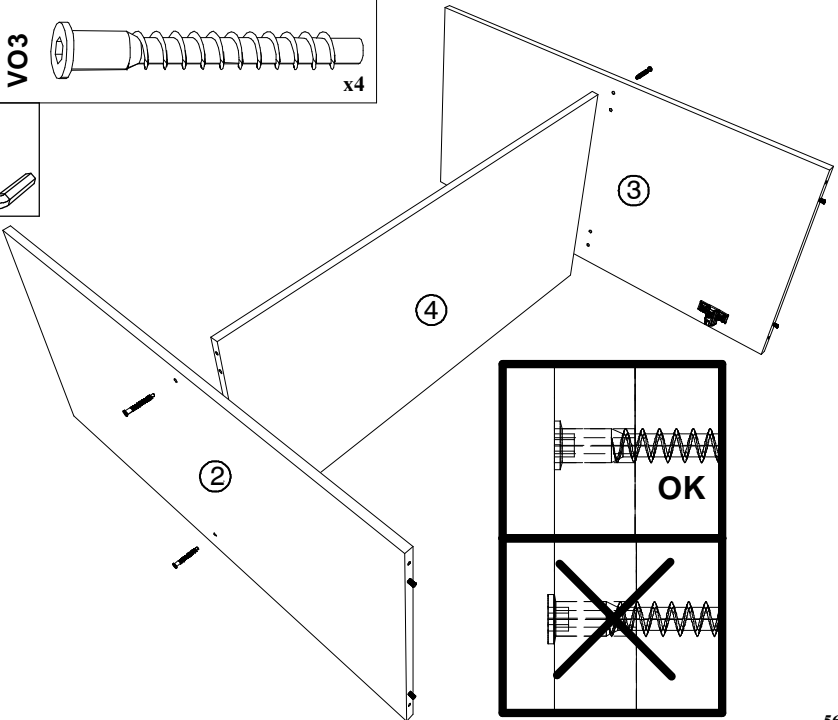
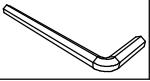

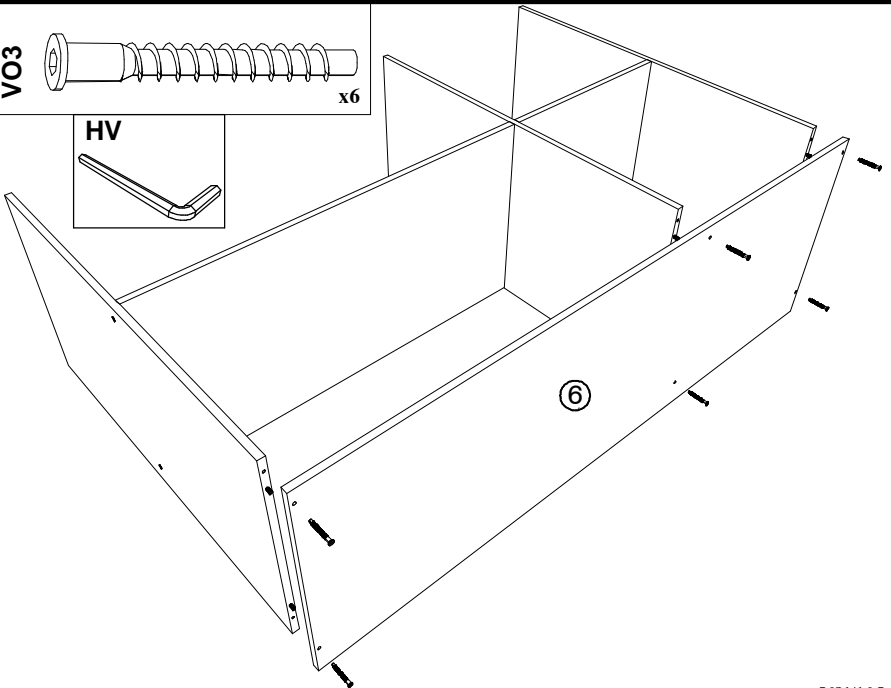
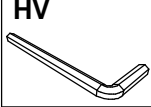
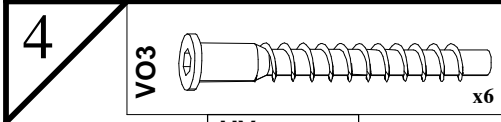
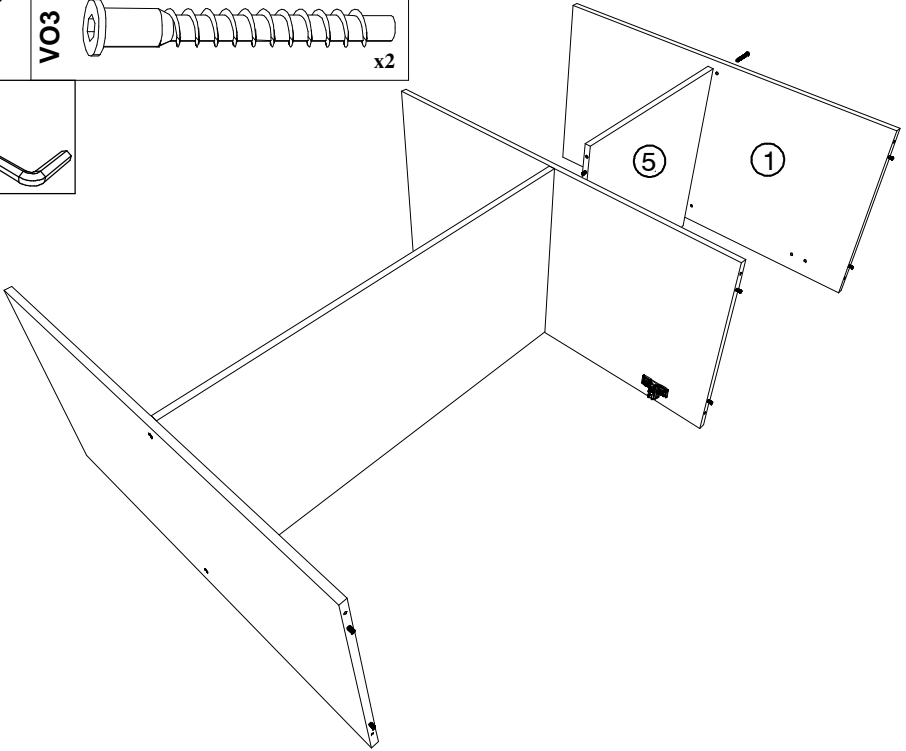
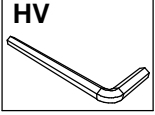
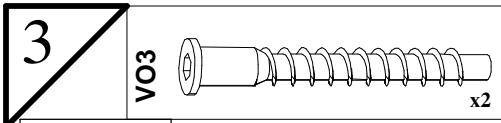

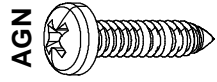
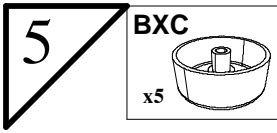

x5

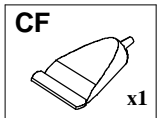
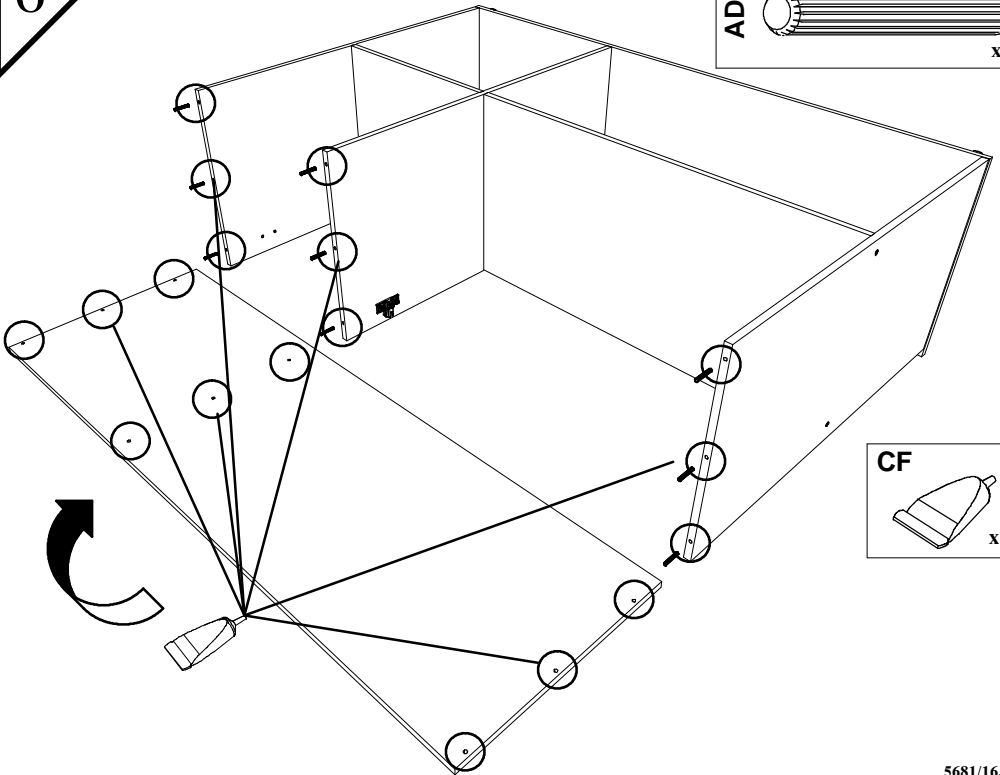
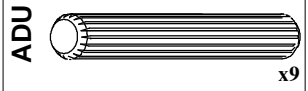
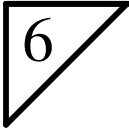
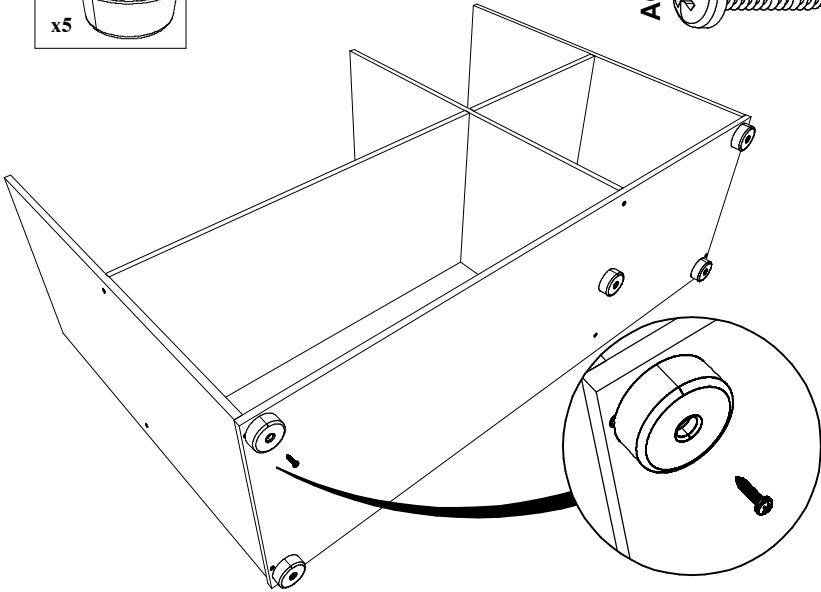

7

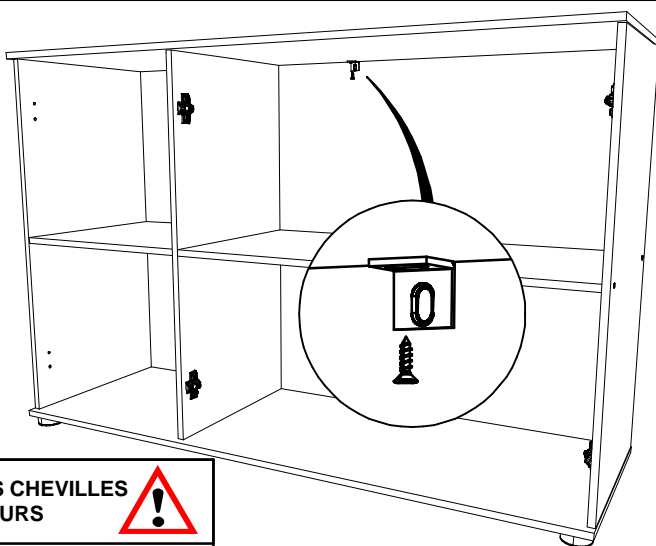
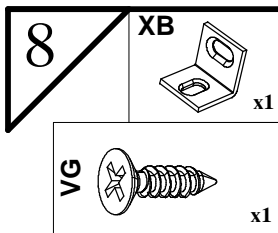
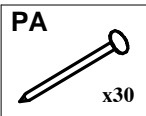
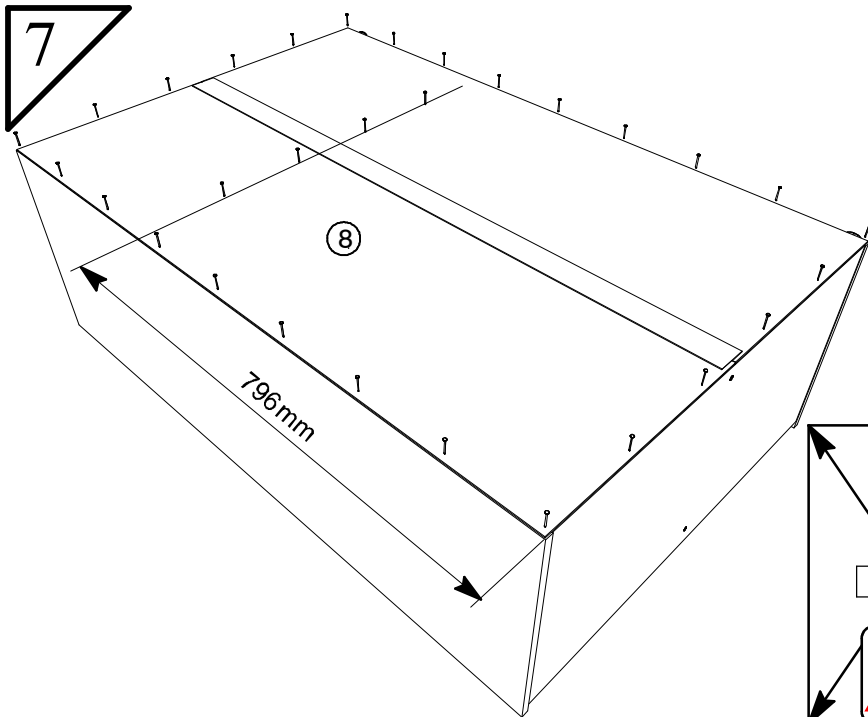

**UTILISER DES VIS ET DES CHEVILLES
ADAPTEES A VOS MURS**



Il existe une grande diversité de type de murs ou cloisons, c'est la raison pour laquelle nous ne pouvons pas vous fournir une quincaillerie adaptée à votre mur. Il est nécessaire d'identifier le type de paroi à laquelle vous allez fixer ce produit afin de vous procurer les fixations appropriées. En cas de besoin, adressez vous à un magasin spécialisé pour conseil.



FIXATION OBLIGATOIRE



